

JVC KD-R200

CD RECEIVER: INSTRUCTIONS/INSTALLATION

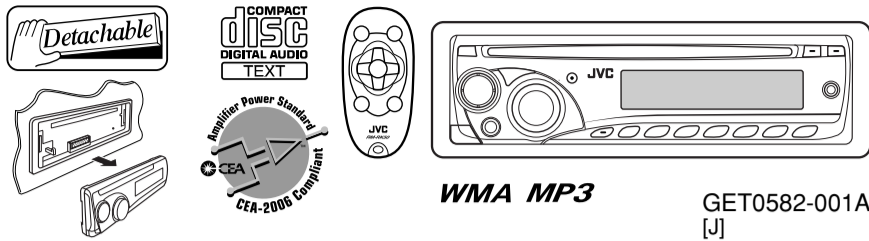

Thank you for purchasing a JVC product.

Please read all instructions carefully before operation, to ensure your complete understanding and to obtain the best possible performance from the unit.

Installation/connection are explained at the last section of this manual (reverse page, indicated with symbol).

For customer Use:

Enter below the Model No. and Serial No. which are located on the top or bottom of the cabinet. Retain this information for future reference.

Model No. _____

Serial No. _____

0708DTSMDTJEIN
EN

© 2008 Victor Company of Japan, Limited

ENGLISH

INFORMATION (For U.S.A.)

This equipment has been tested and found to comply with the limits for a Class B digital device, pursuant to Part 15 of the FCC Rules. These limits are designed to provide reasonable protection against harmful interference in a residential installation. This equipment generates, uses, and can radiate radio frequency energy and, if not installed and used in accordance with the instructions, may cause harmful interference to radio communications. However, there is no guarantee that interference will not occur in a particular installation. If this equipment does cause harmful interference to radio or television reception, which can be determined by turning the equipment off and on, the user is encouraged to try to correct the interference by one or more of the following measures:

- Reorient or relocate the receiving antenna.
- Increase the separation between the equipment and receiver.
- Connect the equipment into an outlet on a circuit different from that to which the receiver is connected.
- Consult the dealer or an experienced radio/TV technician for help.

Caution

Changes or modifications not approved by JVC could void the user's authority to operate the equipment.

IMPORTANT FOR LASER PRODUCTS

- CLASS 1 LASER PRODUCT
- CAUTION:** Do not open the top cover. There are no user serviceable parts inside the unit; leave all servicing to qualified service personnel.
- CAUTION:** (For U.S.A.) Visible and/or invisible class II laser radiation when open. Do not stare into beam. (For Canada) Visible and/or invisible class 1M laser radiation when open. Do not view directly with optical instruments.
- REPRODUCTION OF LABEL: CAUTION LABEL, PLACED OUTSIDE THE UNIT.

CAUTION VISIBLE AND/OR INVISIBLE CLASS 1M LASER RADIATION WHEN OPEN. DO NOT VIEW DIRECTLY WITH OPTICAL INSTRUMENTS. IEC60825-1:2001 (ENX)	ATTENTION RAYONNEMENT LASER VISIBLE ET/OU INVISIBLE DE CLASSE 1M LORSQU'ON OUVRE LE CAS. NE PAS REGARDER DIRECTEMENT AVEC DES INSTRUMENTS OPTIQUES. (FR)	AVISO RADIACION LASER VISIBLE Y/O INVISIBLE DE CLASE 1M CUANDO ESTA ABIERTO. NO MIRAR DIRECTAMENTE CON INSTRUMENTOS OPTICOS. (ES)	VARNING SYNLIG OCH/ELLER OSYNLIG LASERSTRÅLNING, KLASS 1M, NÄR DENNA LÄSAR ÖPPNAD. BETRAKTA EJ STRÅLEN MED OPTISKA INSTRUMENT. (SVE)	注意 ここに警告くど埋蔵 及び/または不可視 のクラス1M レーザー放射が 加ります。 光学機器で直接 見ないでください。 (JPN)	CAUTION VISIBLE AND/OR INVISIBLE CLASS II LASER RADIATION WHEN OPEN. DO NOT STARE INTO BEAM. FDA 21 CFR (ENX)
--	---	--	--	--	--



MORE ABOUT THIS UNIT

Basic operations

- By pressing SRC on the unit, you can also turn on the power. If the source is ready, playback also starts.
- If you turn off the power while listening to a disc, disc play will start from where it had been stopped previously next time you turn on the power.
- When no disc is loaded in the unit, you cannot select "CD" as the playback source.

Tuner operations

- During SSM search...
 - All previously stored stations are erased and the stations are stored anew.
 - Received stations are preset in No. 1 (lowest frequency) to No. 6 (highest frequency).
 - When SSM is over, the station stored in No. 1 will be automatically tuned in.

Disc operations

Caution for DualDisc playback

- The Non-DVD side of a "DualDisc" does not comply with the "Compact Disc Digital Audio" standard. Therefore, the use of Non-DVD side of a DualDisc on this product may not be recommended.

General

- This unit has been designed to reproduce CDs/CD Texts, and CD-Rs (Recordable)/CD-RWs (Rewritable) in audio CD (CD-DA) and MP3/WMA formats.
- After ejecting a disc, "NO DISC" appears and you cannot operate some of the buttons. Insert another disc or press SRC to select another playback source.

Playing a CD-R or CD-RW

- Use only "finalized" CD-Rs or CD-RWs.
- This unit can play back multi-session discs; however, unclosed sessions will be skipped while playing.
- Some CD-Rs or CD-RWs may not be played back on this unit:
 - Discs are dirty or scratched.
 - Moisture condensation has occurred on the lens inside the unit.
 - The pickup lens inside the unit is dirty.
 - The files on the CD-R/CD-RW are written using the "Packet Write" method.

- There are improper recording conditions (missing data, etc.) or media conditions (stained, scratched, warped, etc.).
- CD-RWs may require a longer readout time since the reflectance of CD-RWs is lower than that of regular CDs.

Playing an MP3/WMA disc

- This unit can play back MP3/WMA files with the extension code <.mp3> or <.wma> (regardless of the letter case—upper/lower).
- This unit can show the names of albums, artists (performer), and tag (Version 1.0, 1.1, 2.2, 2.3, or 2.4) for MP3 files and for WMA files.
- This unit can display only one-byte characters. No other characters can be correctly displayed.
- This unit can play back MP3/WMA files meeting the conditions below:
 - Bit rate: 8 kbps — 320 kbps
 - Sampling frequency: 48 kHz, 44.1 kHz, 32 kHz (for MPEG-1) 24 kHz, 22.05 kHz, 16 kHz (for MPEG-2)
 - Disc format: ISO 9660 Level 1/ Level 2, Romeo, Joliet, Windows long file name
- The maximum number of characters for file/folder names vary depending on the disc format used (includes 4 extension characters—<.mp3> or <.wma>).
 - ISO 9660 Level 1: up to 12 characters; ISO 9660 Level 2: up to 31 characters; Romeo: up to 64 characters; Joliet: up to 32 characters; Windows long file name: up to 126 characters
- This unit can recognize a total of 512 files, 255 folders, and 8 hierarchical levels. Files recorded in VBR have a discrepancy in the elapsed time display, and do not show the actual elapsed time. In particular, this difference becomes noticeable after performing the search function.
- This unit cannot play back the following files:
 - MP3 files encoded in: MP3i and MP3 PRO format, in an inappropriate format, layer 1/2.
 - WMA files: encoded in lossless, professional, and voice format; not based upon Windows Media® Audio; copy-protected with DRM.
 - Files which have data such as WAVE, ATRAC3, etc.
- The search function works but search speed is not constant.

For safety...

- Do not raise the volume level too much, as this will block outside sounds, making driving dangerous.
- Stop the car before performing any complicated operations.

Temperature inside the car...

If you have parked the car for a long time in hot or cold weather, wait until the temperature in the car becomes normal before operating the unit.

Warning

If you need to operate the unit while driving, be sure to look around carefully or you may be involved in a traffic accident.

Caution on volume setting

Discs produce very little noise compared with other sources. Lower the volume before playing a disc to avoid damaging the speakers by the sudden increase of the output level.

MAINTENANCE

How to clean the connectors

Wipe the connectors with a cotton swab or cloth moistened with alcohol.

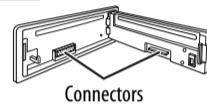

Connectors

To keep discs clean

Wipe in a straight line from center of disc to edge. Do not use liquid cleaners, thinners, or benzene.



Moisture condensation

Moisture may condense on the lens inside the unit. Eject the disc and leave the unit turned on for a few hours until the moisture has evaporated.

To play new discs

Remove any rough areas from the inner and outer edges of the disc.



Do not use the following discs:

Single CD—8 cm (3-3/16") disc



Unusual shape



Warped disc



C-thru Disc (semi-transparent disc)



Sticker and sticker residue



Transparent or semi-transparent parts on its recording area



PREPARATIONS

How to reset your unit

Reset the unit after installation is complete.

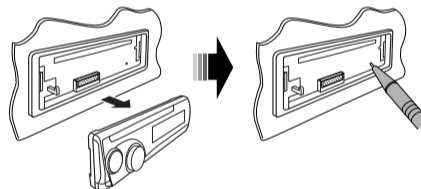

- Your preset adjustments will also be erased.

Detaching the control panel

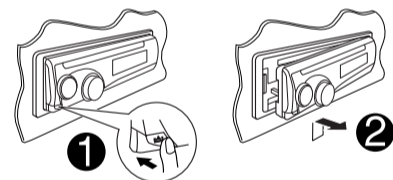

Attaching the control panel

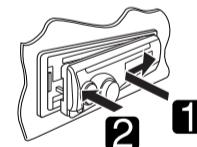

How to forcibly eject a disc

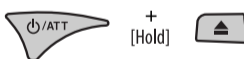

- Be careful not to drop the disc when it ejects.
- If this does not work, reset your unit.

Basic settings

- Enter PSM menu.**
SEL [Hold]
- Select an item.**
- Adjust.**
 [Turn]
- Finish**
SEL

Cancel the display demonstration

DEMO

DEMO OFF

Deactivate the display demonstration.

Set the clock

CLOCK H

CLOCK M

Adjust the hour.

Adjust the minute.

Basic operations

Control panel

- Turn on the power.
- Turn off the power [Hold].
- Attenuate the sound (if the power is on).

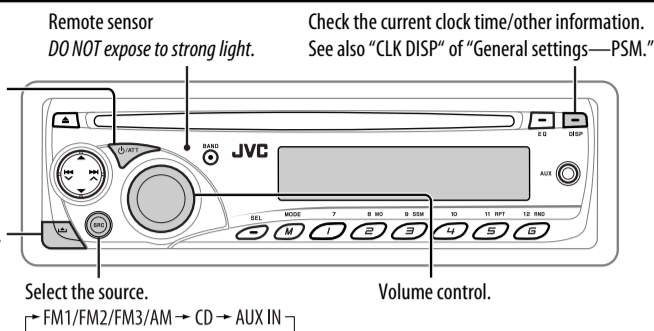

Display window

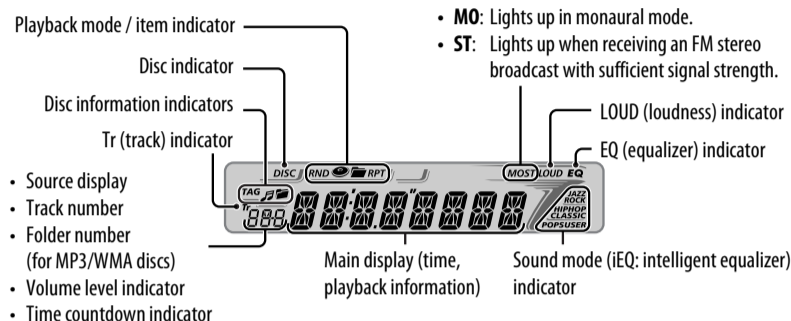

Remote controller—RM-RK50

■ Installing battery

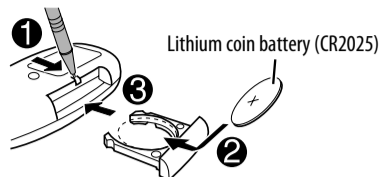

Warning: To prevent accidents and damage

- Do not install any battery other than CR2025 or its equivalent.
- Store out of reach of children.
- Do not recharge, short, or dismantle.
- Do not dispose of in fire.
- Do not carry around with other metallic materials.

For USA-California Only: This product contains a CR Coin Cell Lithium Battery which contains Perchlorate Material—special handling may apply. See www.dtsc.ca.gov/hazardouswaste/perchlorate

■ Features

- Turns the power on if pressed briefly or attenuates the sound when power is on.
- Turns the power off if pressed and held.
- Changes the FM/AM bands with ▲ U.
- Changes the preset stations with D ▼.
- Changes the folders of MP3/WMA discs.
- Selects the sound mode (iEQ: intelligent equalizer).
- Selects the source.
- Searches for stations if pressed briefly.
- Fast-forwards or reverses the track if pressed and held.
- Changes the track of the disc if pressed briefly.
- Adjusts the volume level.

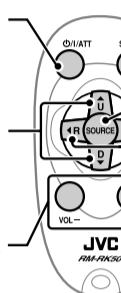

Radio operations

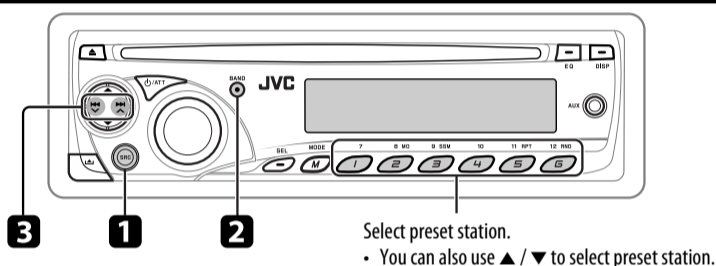

1 Select "FM/AM."

2 Select the bands. FM1 → FM2 → FM3 → AM

3 Search for a station—Auto Search.

Manual Search: Hold either one of the buttons until "M" flashes on the display, then press it repeatedly.

When an FM stereo broadcast is hard to receive

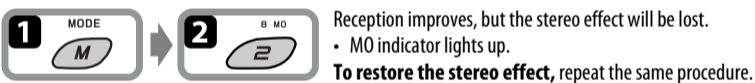

FM station automatic presetting—SSM (Strong-station Sequential Memory)

You can preset six stations for each band.



Manual presetting

Example: Storing the FM station of 92.5 MHz into preset number 4 of the FM1 band.

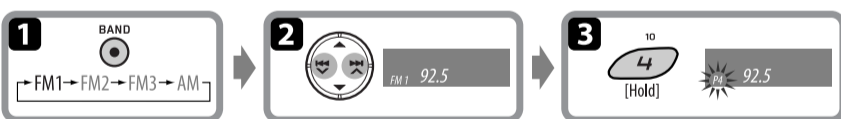

External component operations

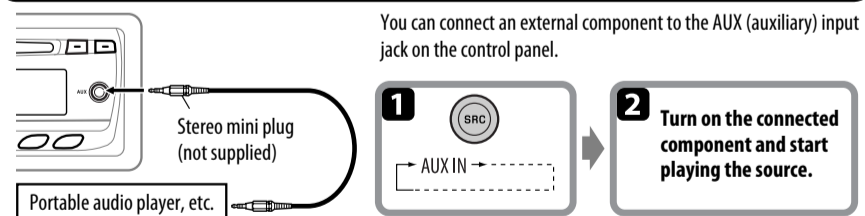

Disc operations

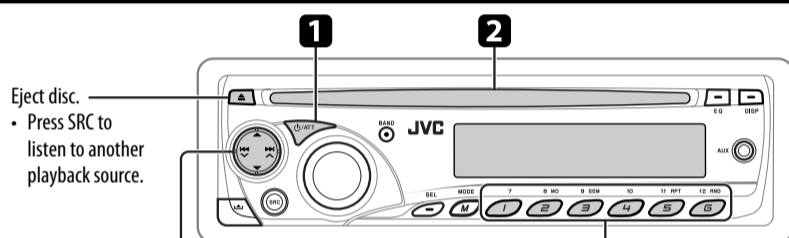

- Press SRC to listen to another playback source.
- [Press] Go to the next or previous track.
- [Hold] Fast-forwards or reverses the track.
- ▲ / ▼ : Go to the next or previous folder (for MP3/WMA discs).

- [Press] Select track (for CD) or folder* (for MP3/WMA) number (01 – 06).
 - [Hold] Select track (for CD) or folder* (for MP3/WMA) number (07 – 12).
- * Folders are required to be assigned with 2-digit numbers at the beginning.

1 Turn on the power.

- 2 Insert disc.** All tracks will be played repeatedly until you change the source or eject the disc.

Selecting the playback modes

After pressing M MODE, press the following buttons to...

- 5 TRK RPT** : Plays the current track repeatedly.
- FLDR RPT*** : Plays all tracks of the current folder repeatedly.
- RPT OFF** : Cancels.
- 6 FLDR RND*** : Plays all tracks of the current folder, then the tracks of the next folder at random.
- ALL RND** : Plays all tracks of the current disc at random.
- RND OFF** : Cancels.

* Only for MP3/WMA.

Skipping a track quickly during play

- For MP3/WMA disc, you can skip a track within the same folder.

Example: Select track 32

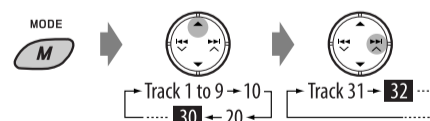

Changing the display information

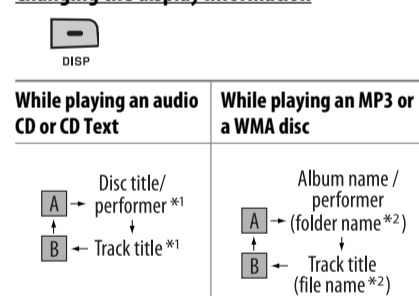

- A** : Clock with the current track number
- B** : The elapsed playing time with the current track number

- *1 If the current disc is an audio CD, "NO NAME" appears.
- *2 If an MP3/WMA file does not have tags or "TAG DISP" is set to "TAG OFF," folder name and file name appear.

Prohibiting disc ejection

You can lock a disc in the loading slot.



To cancel the prohibition, repeat the same procedure.

SETTINGS

■ Sound adjustments



Preset values	BAS (bass)	MID (mid-range)	TRE (treble)	LOUD (loudness)
USER (Flat sound)	00	00	00	OFF
ROCK (Rock or disco music)	+03	00	+02	OFF
CLASSIC (Classical music)	+01	00	+03	OFF
POPS (Light music)	+02	+01	+02	OFF
HIP HOP (Funk or rap music)	+04	-02	+01	OFF
JAZZ (Jazz music)	+03	00	+03	OFF

■ Adjusting the sound

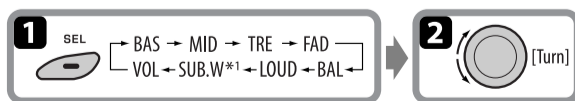

- BAS***2 (bass) : Adjust the bass. -06 to +06
- MID***2 (mid-range) : Adjust the middle frequencies sound level. -06 to +06
- TRE***2 (treble) : Adjust the treble. -06 to +06
- FAD***3 (fader) : Adjust the front and rear speaker balance. R06 to F06
- BAL** (balance) : Adjust the left and right speaker balance. L06 to R06

- LOUD***4 (loudness) : Boost low and high frequencies to produce a well-balanced sound at a low volume level. LOUD ON or LOUD OFF
- SUB.W** (subwoofer) : Adjust the subwoofer output level. 00 to 08
- VOL** (volume) : Adjust the volume. 00 to 50 (or 00 to 30)*5

*1 Displayed only when "L/O MODE" is set to "WOOFER."
 *2 When you adjust the bass, mid-range, or treble, the adjustment you have made is stored for the currently selected sound mode (iEQ) including "USER."
 *3 If you are using a two-speaker system, set the fader level to "00."
 *4 The adjustment made (LOUD ON/LOUD OFF) will be applied to all sound modes (iEQ).
 *5 Depending on the amplifier gain control setting. See reverse page →

General settings—PSM

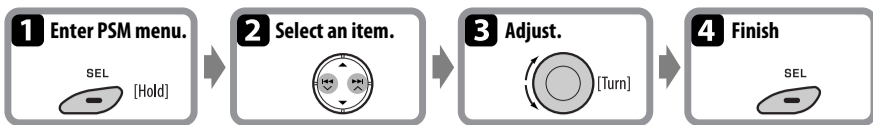

Indication	Item (__ : Initial)	Setting
DEMO	<ul style="list-style-type: none"> DEMO ON DEMO OFF 	<ul style="list-style-type: none"> Display demonstration will be activated automatically if no operation is done for about 20 seconds. Cancels.
CLK DISP *1	<ul style="list-style-type: none"> ON OFF 	<ul style="list-style-type: none"> Clock time is shown on the display at all times when the power is turned off. Cancels; pressing DISP will show the clock time for about 5 seconds when the power is turned off.
CLOCK H (Hour)	1 – 12	: [Initial: 1 (1:00)]
CLOCK M (Minute)	00 – 59	: [Initial: 00 (1:00)]
DIMMER	<ul style="list-style-type: none"> ON OFF 	<ul style="list-style-type: none"> Dims the display and button illumination. Cancels.
SCROLL *2	<ul style="list-style-type: none"> ONCE AUTO OFF 	<ul style="list-style-type: none"> Scrolls the displayed information once. Repeats scrolling (at 5-second intervals). Cancels. Pressing DISP for more than one second can scroll the display regardless of the setting.
L/O MODE	<ul style="list-style-type: none"> REAR WOOFER 	<ul style="list-style-type: none"> Select if the REAR LINE OUT terminals are used for connecting the speakers (through an external amplifier). Select if the REAR LINE OUT terminals are used for connecting a subwoofer.
WOOFER *3	<ul style="list-style-type: none"> LOW MID HIGH 	<ul style="list-style-type: none"> Frequencies lower than 90 Hz are sent to the subwoofer. Frequencies lower than 135 Hz are sent to the subwoofer. Frequencies lower than 180 Hz are sent to the subwoofer.
AUX ADJ	A.ADJ 00 – A.ADJ 05	<ul style="list-style-type: none"> Adjust the auxiliary input level to avoid the sudden increase of the output level when changing the source from external component connected to the AUX input jack on the control panel.
TAG DISP	<ul style="list-style-type: none"> TAG ON TAG OFF 	<ul style="list-style-type: none"> Shows the Tag while playing MP3/WMA tracks. Cancels.
AMP GAIN *4	<ul style="list-style-type: none"> LOW PWR HIGH PWR 	<ul style="list-style-type: none"> VOL 00 – VOL 30 (Select if the maximum power of each speaker is less than 50 W to prevent damaging the speaker.) VOL 00 – VOL 50
AREA	<ul style="list-style-type: none"> AREA US AREA EU AREA SA 	<ul style="list-style-type: none"> When using in North/Central/South America. AM/FM intervals are set to 10 kHz/200 kHz. When using in any other areas. AM/FM intervals are set to 9 kHz/50 kHz (100 kHz during auto search). When using in South American countries where FM interval is 100kHz. AM interval is set to 10kHz.

*1 If the power supply is not interrupted by turning off the ignition key of your car, it is recommended that you select "OFF" to save the car's battery.

*2 Some characters or symbols will not be shown correctly (or will be blanked) on the display.

*3 Displayed only when "L/O MODE" is set to "WOOFER."

*4 The volume level automatically changes to "VOL 30" if you change to "LOW PWR" while the volume level is set higher than "VOL 30."

TROUBLESHOOTING

	Symptoms	Remedies/Causes
General	<ul style="list-style-type: none"> Sound cannot be heard from the speakers. 	<ul style="list-style-type: none"> Adjust the volume to the optimum level. Check the cords and connections.
	<ul style="list-style-type: none"> The buttons on the unit do not work as you intended. 	<ul style="list-style-type: none"> If you press M MODE, some buttons work differently from its original function. Wait for 5 seconds or press M MODE again.
	<ul style="list-style-type: none"> This unit does not work at all. 	<ul style="list-style-type: none"> Reset the unit.
FM/AM	<ul style="list-style-type: none"> SSM automatic presetting does not work. 	<ul style="list-style-type: none"> Store stations manually.
	<ul style="list-style-type: none"> Static noise while listening to the radio. 	<ul style="list-style-type: none"> Connect the antenna firmly.
Disc playback	<ul style="list-style-type: none"> Disc ejects. 	<ul style="list-style-type: none"> Insert the disc correctly.
	<ul style="list-style-type: none"> CD-R/CD-RW cannot be played back. Tracks on the CD-R/CD-RW cannot be skipped. 	<ul style="list-style-type: none"> Insert a finalized CD-R/CD-RW. Finalize the CD-R/CD-RW with the component which you used for recording.
	<ul style="list-style-type: none"> Disc can be neither played back nor ejected. 	<ul style="list-style-type: none"> Unlock the disc. Eject the disc forcibly.
	<ul style="list-style-type: none"> Disc sound is sometimes interrupted. 	<ul style="list-style-type: none"> Stop playback while driving on rough roads. Change the disc. Check the cords and connections.
	<ul style="list-style-type: none"> "NO DISC" appears on the display. "PLEASE" and "EJECT" appear alternately on the display. 	<ul style="list-style-type: none"> Insert a playable disc into the loading slot.
MP3/WMA playback	<ul style="list-style-type: none"> Disc cannot be played back. 	<ul style="list-style-type: none"> Use a disc with MP3/WMA tracks recorded in a format compliant with ISO 9660 Level 1, Level 2, Romeo, or Joliet. Add the extension code <.mp3> or <.wma> to the file names.
	<ul style="list-style-type: none"> Noise is generated. 	<ul style="list-style-type: none"> Skip to another track or change the disc. (Do not add the extension code <.mp3> or <.wma> to non-MP3 or WMA tracks.)
	<ul style="list-style-type: none"> A longer readout time is required ("READING" keeps flashing on the display). 	<ul style="list-style-type: none"> Do not use too many hierarchical levels and folders.
	<ul style="list-style-type: none"> Tracks are not played back in the order you have intended. 	<ul style="list-style-type: none"> Playback order is determined when the files are recorded.
	<ul style="list-style-type: none"> The elapsed playing time is not correct. 	<ul style="list-style-type: none"> This sometimes occurs during playback. This is caused by how the tracks are recorded on the disc.
<ul style="list-style-type: none"> The correct characters are not displayed (e.g. album name). 	<ul style="list-style-type: none"> This unit can only display alphabets (upper case), numbers, and a limited number of symbols. 	

• Microsoft and Windows Media are either registered trademarks or trademarks of Microsoft Corporation in the United States and/or other countries.

SPECIFICATIONS

Audio amplifier section

Power Output:
20 W RMS × 4 Channels at 4 Ω and ≤ 1% THD+N
Signal-to-Noise Ratio:
80 dBA (reference: 1 W into 4 Ω)



Load Impedance: 4 Ω (4 Ω to 8 Ω allowance)
Tone Control Range: Bass: ±12 dB at 60 Hz
Mid-range: ±12 dB at 1 kHz
Treble: ±12 dB at 7.5 kHz
Frequency Response: 40 Hz to 20 000 Hz
Line-Out Level/Impedance: 2.5 V/20 kΩ load (full scale)
Output Impedance: 1 kΩ
Subwoofer-Out Level/Impedance: 2.5 V/20 kΩ load (full scale)

If a kit is necessary for your car, consult your telephone directory for the nearest car audio speciality shop.

Tuner section

Frequency Range:
FM: 87.5 MHz to 107.9 MHz
(with channel interval set to 100 kHz or 200 kHz)
87.5 MHz to 108.0 MHz
(with channel interval set to 50 kHz)
AM: 530 kHz to 1 710 kHz
(with channel interval set to 10 kHz)
531 kHz to 1 602 kHz
(with channel interval set to 9 kHz)

[FM Tuner]
Usable Sensitivity: 11.3 dBf (1.0 μV/75 Ω)
50 dB Quieting Sensitivity: 16.3 dBf (1.8 μV/75 Ω)
Alternate Channel Selectivity (400 kHz): 65 dB
Frequency Response: 40 Hz to 15 000 Hz
Stereo Separation: 35 dB

[AM Tuner]
Sensitivity/Selectivity: 20 μV/35 dB

CD player section

Type: Compact disc player
Signal Detection System: Non-contact optical pickup (semiconductor laser)
Number of channels: 2 channels (stereo)
Frequency Response: 5 Hz to 20 000 Hz
Dynamic Range: 93 dB
Signal-to-Noise Ratio: 98 dB
Wow and Flutter: Less than measurable limit
MP3 Decoding Format: MPEG1/2 Audio Layer 3
Max. Bit Rate: 320 kbps
WMA (Windows Media® Audio) Decoding Format: Max. Bit Rate: 192 kbps

Having TROUBLE with operation?
Please reset your unit
Still having trouble??
Call 1-800-252-5722 (USA ONLY)
http://www.jvc.com

General

Power Requirement: Operating Voltage: DC 14.4 V (11 V to 16 V allowance)
Grounding System: Negative ground
Allowable Operating Temperature: 0°C to +40°C (32°F to 104°F)
Dimensions (W × H × D):
Installation Size (approx.):
182 mm × 52 mm × 160 mm
(7-3/16" × 2-1/16" × 6-5/16")
Panel Size (approx.):
188 mm × 58 mm × 5 mm
(7-7/16" × 2-5/16" × 1/4")
Mass (approx.):
1.3 kg (2.9 lbs) (excluding accessories)

Design and specifications are subject to change without notice.

PREPARATION



This unit is designed to operate on **12 V DC, NEGATIVE ground electrical systems**. If your vehicle does not have this system, a voltage inverter is required, which can be purchased at JVC car audio dealers.

Prepare this before installation



WARNINGS



To prevent short circuits, we recommend that you disconnect the battery's negative terminal and make all electrical connections before installing the unit.

- Be sure to ground this unit to the car's chassis again after installation.**

Notes:

- Replace the fuse with one of the specified rating. If the fuse blows frequently, consult your JVC car audio dealer.
- It is recommended to connect to the speakers with maximum power of more than 50 W (both at the rear and at the front, with an impedance of **4 Ω to 8 Ω**). If the maximum power is less than 50 W, change "AMP GAIN" setting to prevent the speakers from being damaged (see "General settings—PSM").
- To prevent short-circuit, cover the terminals of the UNUSED leads with insulating tape.
- The heat sink becomes very hot after use. Be careful not to touch it when removing this unit.

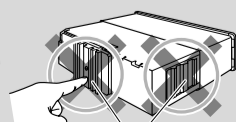

Heat sink

TROUBLESHOOTING



- The fuse blows.**
 - * Are the red and black leads connected correctly?
- Power cannot be turned on.**
 - * Is the yellow lead connected?
- No sound from the speakers.**
 - * Is the speaker output lead short-circuited?
- Sound is distorted.**
 - * Is the speaker output lead grounded?
 - * Are the "-" terminals of L and R speakers grounded in common?
- Noise interfere with sounds.**
 - * Is the rear ground terminal connected to the car's chassis using shorter and thicker cords?
- This unit becomes hot.**
 - * Is the speaker output lead grounded?
 - * Are the "-" terminals of L and R speakers grounded in common?
- This unit does not work at all.**
 - * Have you reset your unit?

Parts list for installation and connection

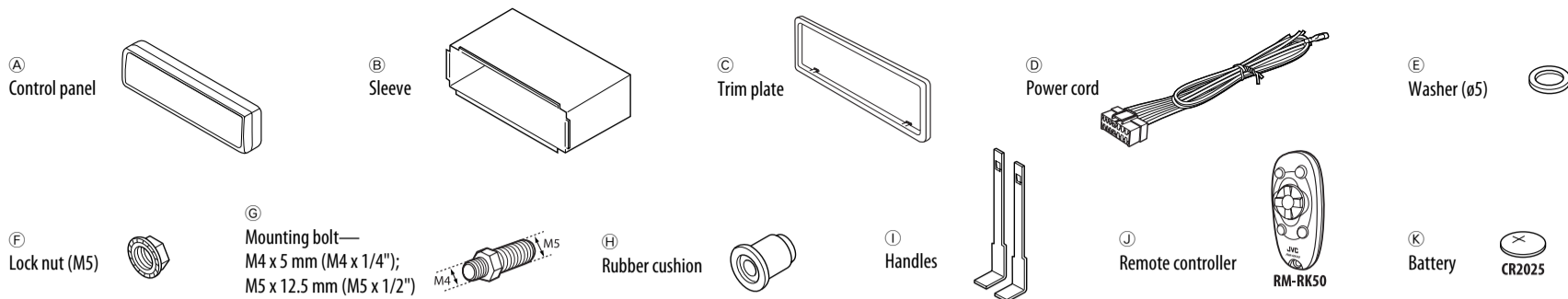

INSTALLATION



The following illustration shows a typical installation. If you have any questions or require information regarding installation kits, consult your JVC car audio dealer or a company supplying kits.

- If you are not sure how to install this unit correctly, have it installed by a qualified technician.

In dash-mounting

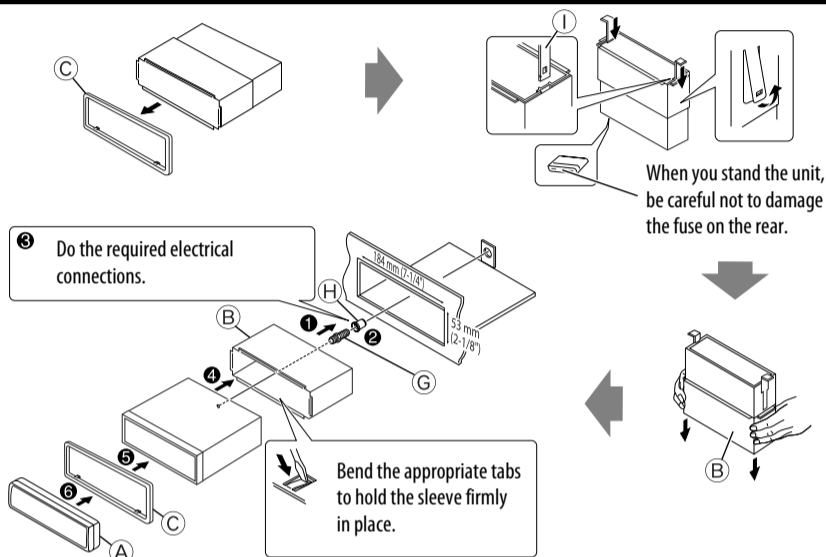

Removing the unit

Before removing the unit, release the rear section.

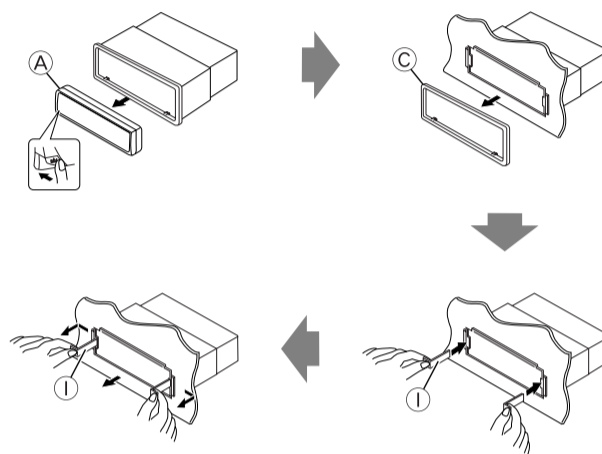

When using the optional stay

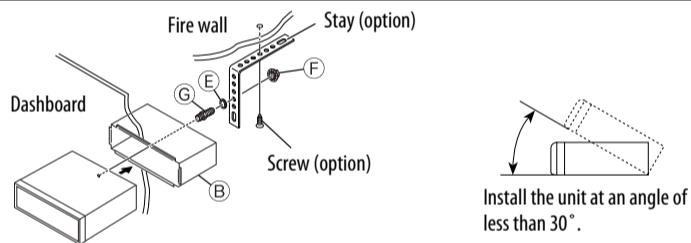

When installing the unit without using the sleeve

In a Toyota car for example, first remove the car radio and install the unit in its place.

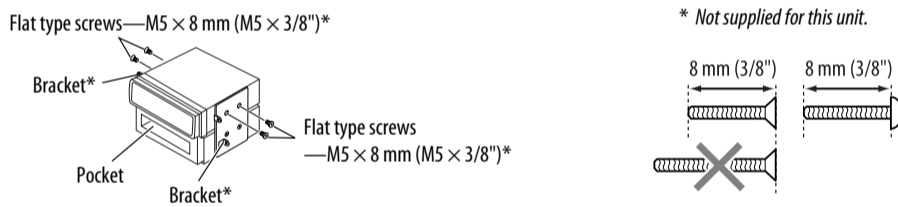

ELECTRICAL CONNECTIONS



Typical connections

Before connecting: Check the wiring in the vehicle carefully. Incorrect connection may cause serious damage to this unit. The leads of the power cord and those of the connector from the car body may be different in color.

- 1 Connect the colored leads of the power cord in the order specified in the illustration below.
- 2 Connect the antenna cord.
- 3 Finally connect the wiring harness to the unit.

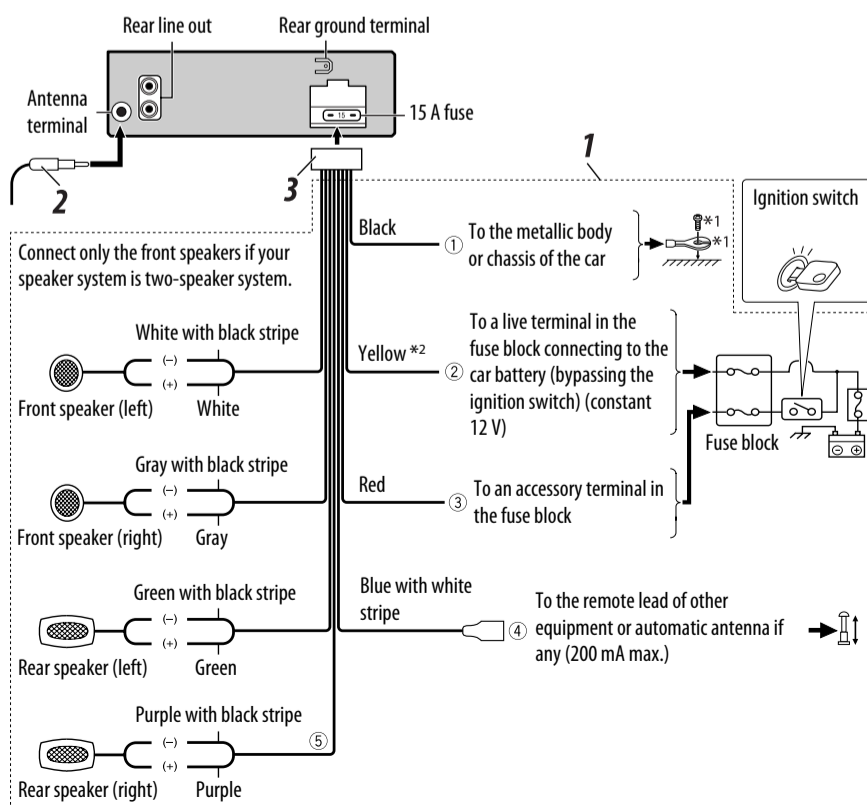

Connecting the external amplifier or subwoofer

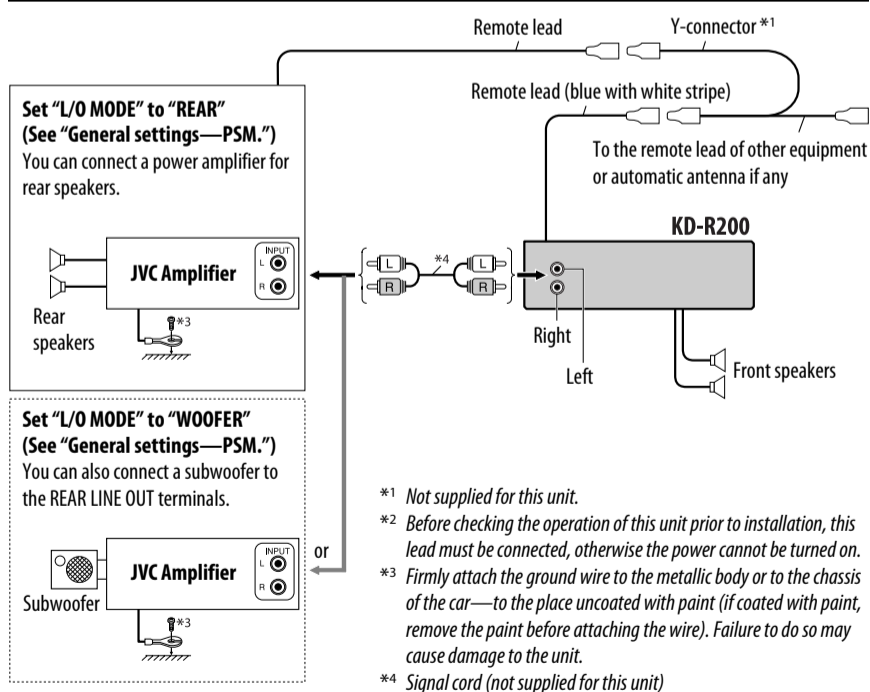

PRECAUTIONS on power supply and speaker connections:

- DO NOT connect the speaker leads of the power cord to the car battery; otherwise, the unit will be seriously damaged.
- BEFORE connecting the speaker leads of the power cord to the speakers, check the speaker wiring in your car.

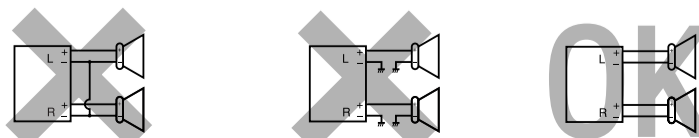

JVC

ENGLISH

FRANÇAIS

CD RECEIVER
RÉCEPTEUR CD

KD-R201

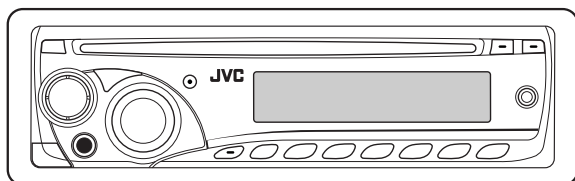
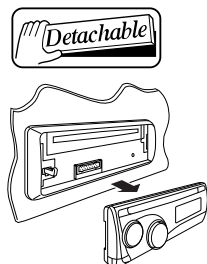

Radio Data System



For canceling the display demonstration, see page 5.

Pour annuler la démonstration des affichages, référez-vous à la page 5.

For installation and connections, refer to the separate manual.

Pour l'installation et les raccordements, se référer au manuel séparé.

INSTRUCTIONS

MANUEL D'INSTRUCTIONS

GET0583-003A
[EX]

Thank you for purchasing a JVC product.

Please read all instructions carefully before operation, to ensure your complete understanding and to obtain the best possible performance from the unit.

IMPORTANT FOR LASER PRODUCTS

- CLASS 1 LASER PRODUCT
- CAUTION:** Do not open the top cover. There are no user serviceable parts inside the unit; leave all servicing to qualified service personnel.
- CAUTION:** Visible and/or invisible class 1M laser radiation when open. Do not view directly with optical instruments.
- REPRODUCTION OF LABEL: CAUTION LABEL, PLACED OUTSIDE THE UNIT.

CAUTION	ATTENTION	AVISO	WARNING	注意	CAUTION
VISIBLE AND/OR INVISIBLE CLASS 1M LASER RADIATION WHEN OPEN. DO NOT VIEW DIRECTLY WITH OPTICAL INSTRUMENTS IEC300625-1:2001 (ENG)	RAYONNEMENT LASER VISIBLE ET/OU INVISIBLE DE CLASSE 1M UNE FOIS OUVERT. NE PAS REGARDER DIRECTEMENT AVEC DES INSTRUMENTS OPTIQUES. (FRA)	RADIACION LASER DE CLASE 1M VISIBLE Y/O INVISIBLE CUANDO ESTA ABIERTO. NO MIRAR DIRECTAMENTE CON INSTRUMENTAL OPTICO. (ESP)	SYNLIG OCH/ELLER SYNLIG LASERSTRÅLNING. KLASS 1M, NÄR DENNA DEL ÄR ÖPPNAD. BETRÄKTA EJ STRÅLEN MED OPTISKA INSTRUMENT. (SWE)	ここを覗くと有害 及びまたは不可視 のクラス1M レーザー放射が 出ます。 光学機器で直接 見ないでください。 (JPN)	VISIBLE AND/OR INVISIBLE CLASS II LASER RADIATION WHEN OPEN. DO NOT STARE INTO BEAM. FDA 21 CFR (ENG)

Warning:

If you need to operate the unit while driving, be sure to look around carefully or you may be involved in a traffic accident.

How to reset your unit

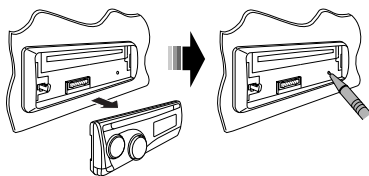

- Your preset adjustments will also be erased.

How to forcibly eject a disc

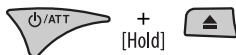

- Be careful not to drop the disc when it ejects.
- If this does not work, reset your unit.

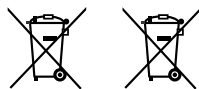

Products

Battery

Information for Users on Disposal of Old Equipment and Batteries (European Union only)

These symbols indicate that the product and the battery with this symbol should not be disposed as general household waste at its end-of-life.

If you wish to dispose of this product and the battery, please do so in accordance with applicable national legislation or other rules in your country and municipality.

By disposing of this product correctly, you will help to conserve natural resources and will help prevent potential negative effects on the environment and human health.

Notice:

The sign Pb below the symbol for batteries indicates that this battery contains lead.

How to use the M MODE button

If you press M MODE, the unit goes into functions mode, then the number buttons and ▲ / ▼ buttons will work as different function buttons.

Ex.: When number button 2 works as MO (monaural) button.



To use these buttons for their original functions again after pressing M MODE, wait for 5 seconds without pressing any of these buttons until the functions mode is cleared, or press M MODE again.

Detaching the control panel

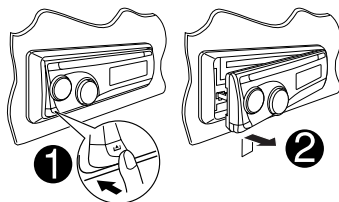

Attaching the control panel

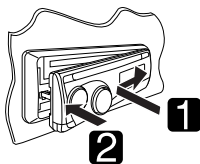

Caution on volume setting:

Discs produce very little noise compared with other sources. Lower the volume before playing a disc to avoid damaging the speakers by the sudden increase of the output level.

CONTENTS

Control panel	4
Getting started	5
Basic operations	5
Radio operations	6
FM Radio Data System operations	7
Searching for your favorite FM Radio Data System programme	7
Disc operations	9
Playing a disc in the unit	9
Sound adjustments	11
General settings — PSM	12
Other external component operations	15
Maintenance	15
More about this unit	16
Troubleshooting	18
Specifications	19

For safety...

- Do not raise the volume level too much, as this will block outside sounds, making driving dangerous.
- Stop the car before performing any complicated operations.

Temperature inside the car...

If you have parked the car for a long time in hot or cold weather, wait until the temperature in the car becomes normal before operating the unit.

Control panel

Parts identification

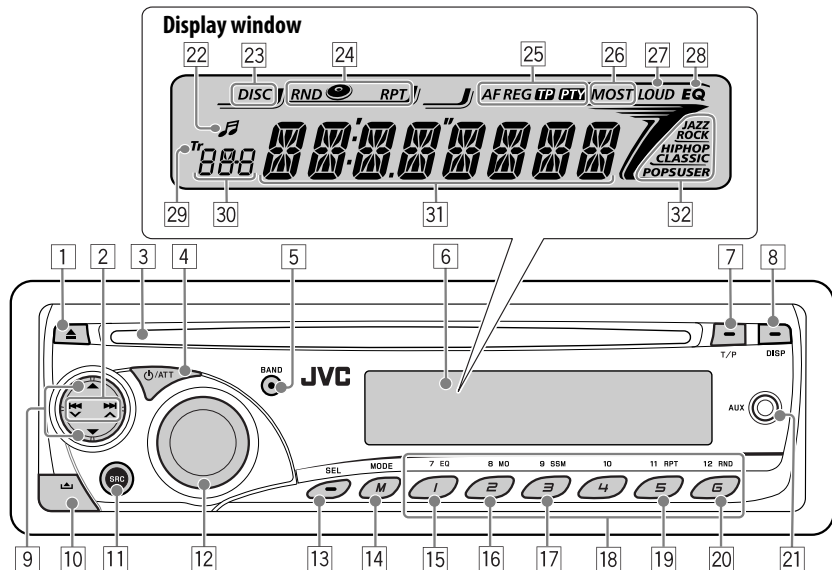

- | | |
|--|--|
| 1 ▲ (eject) button | 19 RPT (repeat) button |
| 2 ◀◀▶▶/▶▶▲ buttons | 20 RND (random) button |
| 3 Loading slot | 21 AUX (auxiliary) input jack |
| 4 ⏻/ATT (standby/attenuator) button | 22 Disc information indicator |
| 5 BAND button | 23 DISC indicator |
| 6 Display window | 24 Playback mode / item indicators—RND (random),
● (disc), RPT (repeat) |
| 7 T/P (traffic programme/programme type) button | 25 Radio Data System indicators—AF, REG, TP, PTY |
| 8 DISP (display) button | 26 Tuner reception indicators—MO (monaural),
ST (stereo) |
| 9 ▲(up)/▼(down) buttons | 27 LOUD (loudness) indicator |
| 10 ▲ (control panel release) button | 28 EQ (equalizer) indicator |
| 11 SRC (source) button | 29 Tr (track) indicator |
| 12 Control dial | 30 Source display / Track number / Volume level
indicator / Time countdown indicator |
| 13 SEL (select) button | 31 Main display |
| 14 M MODE button | 32 Sound mode (c-EQ: custom equalizer) indicators—
JAZZ, ROCK, HIP HOP, CLASSIC, POPS, USER |
| 15 EQ (equalizer) button | |
| 16 MO (monaural) button | |
| 17 SSM (Strong-station Sequential Memory) button | |
| 18 Number buttons | |

Getting started

Basic operations

1 Turn on the power.



* You cannot select "CD" as the playback source if there is no disc in the unit.

3 For FM/AM tuner



4 Adjust the volume.

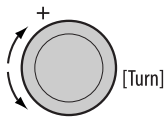

VOL 20

Volume level appears.

5 Adjust the sound as you want. (See pages 11 and 12.)

To drop the volume in a moment (ATT)

To restore the sound, press the button again.



To turn off the power



Basic settings

• See also "General settings — PSM" on pages 12 – 14.

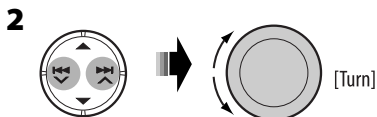

1 **Canceling the display demonstrations**
Select "DEMO," then "DEMO OFF."

2 **Setting the clock**

Select "CLOCK H" (hour), then adjust the hour.
Select "CLOCK M" (minute), then adjust the minute.

Select "24H/12H," then "24H" (hour) or "12H" (hour).

3 Finish the procedure.



To check the current clock time while the power is turned off



Clock time is shown on the display for about 5 seconds. See also page 13.

Radio operations



Lights up when receiving an FM stereo broadcast with sufficient signal strength.



3 Start searching for a station.



When a station is received, searching stops. **To stop searching**, press the same button again.

To tune in to a station manually

In step 3 above...

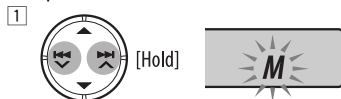

2 Select a desired station frequency.



When an FM stereo broadcast is hard to receive



Lights up when monaural mode is activated.



Reception improves, but the stereo effect will be lost.

To restore the stereo effect, repeat the same procedure. "MONO OFF" appears and the MO indicator goes off.

Storing stations in memory

You can preset six stations for each band.

FM station automatic presetting—SSM (Strong-station Sequential Memory)

1 Select the FM band (FM1 – FM3) you want to store into.

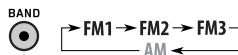



"SSM" flashes, then disappears when automatic presetting is over.

Local FM stations with the strongest signals are searched and stored automatically in the FM band.

Manual presetting

Ex.: Storing the FM station of 92.5 MHz into preset number 4 of the FM1 band.

- 
- 
- 

Preset number flashes for a while.

Listening to a preset station

- 
- Select the preset station (1 – 6) you want.

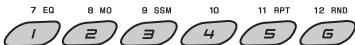

To check the current clock time while listening to an FM (non-Radio Data System) or AM station

- For FM Radio Data System stations, see page 9.



FM Radio Data System operations

What you can do with Radio Data System

Radio Data System allows FM stations to send an additional signal along with their regular programme signals.

By receiving the Radio Data System data, this unit can do the following:

- Programme Type (PTY) Search (see the following)
- TA (Traffic Announcement) and PTY Standby Receptions (see pages 8, 9, 13 and 14)
- Tracing the same programme automatically —Network-Tracking Reception (see page 9)
- Programme Search (see pages 9 and 14)

Searching for your favorite FM Radio Data System programme

You can tune in to a station broadcasting your favorite programme by searching for a PTY code.

- To store your favorite programme types, see page 8.

-  [Hold] The last selected PTY code appears.
- Select one of your favorite programme types.



or

Select one of the PTY codes (see page 9).



Continued on the next page

3 Start searching for your favorite programme.



If there is a station broadcasting a programme of the same PTY code as you have selected, that station is tuned in.

Storing your favorite programme types

You can store six favorite programme types.

Preset programme types in the number buttons (1 to 6):

1	2	3	4	5	6
POP M	ROCK M	EASY M	CLASSICS	AFFAIRS	VARIED

- 1 Select a PTY code (see pages 7 and 8).
- 2 Select the preset number (1 – 6) you want to store into.

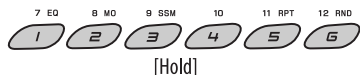

Ex.: When "ROCK M" is selected

- 3 Repeat steps 1 and 2 to store other PTY codes into other preset numbers.
- 4 Finish the procedure.



Using the standby receptions

TA Standby Reception

TA Standby Reception allows the unit to switch temporarily to Traffic Announcement (TA) from any source other than AM.

The volume changes to the preset TA volume level if the current level is lower than the preset level (see page 14).

To activate TA Standby Reception



The TP (Traffic Programme) indicator either lights up or flashes.

- If the TP indicator lights up, TA Standby Reception is activated.
- If the TP indicator flashes, TA Standby Reception is not yet activated. (This occurs when you are listening to an FM station without the Radio Data System signals required for TA Standby Reception.)
To activate TA Standby Reception, tune in to another station providing these signals. The TP indicator will stop flashing and remain lit.

To deactivate the TA Standby Reception



The TP indicator goes off.

PTY Standby Reception

PTY Standby Reception allows the unit to switch temporarily to your favorite PTY programme from any source other than AM.

To activate and select your favorite PTY code for PTY Standby Reception, see page 13.

The PTY indicator either lights up or flashes.

- If the PTY indicator lights up, PTY Standby Reception is activated.
- If the PTY indicator flashes, PTY Standby Reception is not yet activated.

To activate PTY Standby Reception, tune in to another station providing these signals. The PTY indicator will stop flashing and remain lit.

To deactivate the **PTY Standby Reception**, select "OFF" for the PTY code (see page 13). The PTY indicator goes off.

Tracing the same programme— Network-Tracking Reception

When driving in an area where FM reception is not sufficient enough, this unit automatically tunes in to another FM Radio Data System station of the same network, possibly broadcasting the same programme with stronger signals (see the illustration below).

When shipped from the factory, Network-Tracking Reception is activated.

To change the **Network-Tracking Reception setting**, see "AF-REG" on page 13.

Programme A broadcasting on different frequency areas (01 – 05)

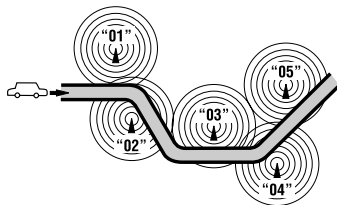

Automatic station selection— Programme Search

Usually when you press the number buttons, the preset station is tuned in.

If the signals from the FM Radio Data System preset station are not sufficient for good reception, this unit, using the AF data, tunes in to another frequency broadcasting the same programme as the original preset station is broadcasting.

- The unit takes some time to tune in to another station using programme search.
- See also page 14.

To check the current clock time while listening to an FM Radio Data System station



DISP

Station name (PS) → Station Frequency → Programme type (PTY) → Clock → (back to the beginning)

PTY codes

NEWS, AFFAIRS, INFO, SPORT, EDUCATE, DRAMA, CULTURE, SCIENCE, VARIOUS, POP M (music), ROCK M (music), EASY M (music), LIGHT M (music), CLASSICS, OTHER M (music), WEATHER, FINANCE, CHILDREN, SOCIAL, RELIGION, PHONE IN, TRAVEL, LEISURE, JAZZ, COUNTRY, NATION M (music), OLDIES, FOLK M (music), DOCUMENT

Disc operations

Playing a disc in the unit

- 1 Turn on the power.



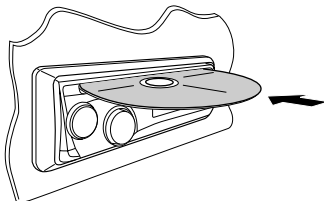

- 2



All tracks will be played repeatedly until you change the source or eject the disc.

Continued on the next page

To stop play and eject the disc • Press SRC to listen to another playback source.	
To fast-forward or reverse the track	 [Hold]
To go to the next or previous track	

To locate a particular track directly

To select a number from 01 – 06:



To select a number from 07 – 12:

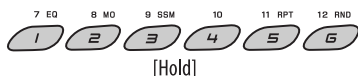

Other main functions

■ Skipping tracks quickly during play

Ex.: To select track 32 while playing a track whose number is a single digit (1 to 9)



Each time you press the button, you can skip 10 tracks.

- After the last track, the first track will be selected and vice versa.

3



■ Prohibiting disc ejection

You can lock a disc in the loading slot.

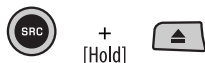

To cancel the prohibition, repeat the same procedure.

Changing the display information



The elapsed playing time with the current track number → Clock with the current track number → Disc title/performer* → Track title* [♪] → (back to the beginning)

[] : Corresponding indicator lights up on the display.

* If the current disc is an audio CD, "NO NAME" appears.

Selecting the playback modes

You can use only one of the following playback modes at a time.



2 Select your desired playback mode.

■ Repeat play



Mode Plays repeatedly

TRK RPT : The current track. [RPT]

RPT OFF : Cancels.

■ Random play



Mode Plays at random

ALL RND : All tracks of the current disc.
[RND]

RND OFF : Cancels.

[] : Corresponding indicator lights up on the display.

Sound adjustments

You can select a preset sound mode suitable to the music genre (c-EQ: custom equalizer).

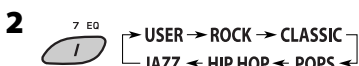

Preset values Indication (For)	BAS (bass)	TRE (treble)	LOUD (loudness)
	USER (Flat sound)	00	00
ROCK (Rock or disco music)	+03	+01	ON
CLASSIC (Classical music)	+01	-02	OFF
POPS (Light music)	+04	+01	OFF
HIP HOP (Funk or rap music)	+02	00	ON
JAZZ (Jazz music)	+02	+03	OFF

Continued on the next page

Adjusting the sound

You can adjust the sound characteristics to your preference.

- 

SEL

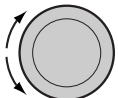
BAS → TRE → FAD
VOL ← LOUD ← BAL
- 

[Turn]

Indication, [Range]

BAS*¹ (bass), [-06 to +06]

Adjust the bass.

TRE*¹ (treble), [-06 to +06]

Adjust the treble.

FAD*² (fader), [R06 to F06]

Adjust the front and rear speaker balance.

BAL (balance), [L06 to R06]

Adjust the left and right speaker balance.

LOUD*¹ (loudness), [LOUD ON or LOUD OFF]

Boost low and high frequencies to produce a well-balanced sound at a low volume level.

VOL (volume), [00 to 50 or 00 to 30]*³

Adjust the volume.

*¹ When you adjust the bass, treble, or loudness, the adjustment you have made is stored for the currently selected sound mode (c-EQ) including "USER."

*² If you are using a two-speaker system, set the fader level to "00."

*³ Depending on the amplifier gain control setting. (See page 14 for details.)

General settings — PSM

You can change PSM (Preferred Setting Mode) items listed on pages 13 and 14.

- 

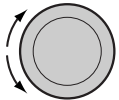
[Hold]
- Select a PSM item.
 
- Adjust the PSM item selected.
 

[Turn]
- Repeat steps 2 and 3 to adjust other PSM items if necessary.
- Finish the procedure.



Indications	Item (__: Initial)	Selectable settings, [reference page]
DEMO Display demonstration	<ul style="list-style-type: none"> • DEMO ON • DEMO OFF 	<ul style="list-style-type: none"> : Display demonstration will be activated automatically if no operation is done for about 20 seconds, [5]. : Cancels.
CLK DISP *1 Clock display	<ul style="list-style-type: none"> • ON • OFF 	<ul style="list-style-type: none"> : Clock time is shown on the display at all times when the power is turned off. : Cancels; pressing DISP will show the clock time for about 5 seconds when the power is turned off, [5].
CLOCK H Hour adjustment	0 – 23 (1 – 12)	[Initial: 0 (0:00)], [5].
CLOCK M Minute adjustment	00 – 59	[Initial: 00 (0:00)], [5].
24H/12H Time display mode	<ul style="list-style-type: none"> • 24H • 12H 	: See also page 5 for setting.
CLK ADJ *2 Clock adjustment	<ul style="list-style-type: none"> • AUTO • OFF 	<ul style="list-style-type: none"> : The built-in clock is automatically adjusted using the CT (clock time) data in the Radio Data System signal. : Cancels.
AF-REG *2 Alternative frequency/ regionalization reception	<ul style="list-style-type: none"> • AF • AF REG • OFF 	<ul style="list-style-type: none"> : When the currently received signals become weak, the unit switches to another station (the programme may differ from the one currently received), [9, 16]. <ul style="list-style-type: none"> • The AF indicator lights up. : When the currently received signals become weak, the unit switches to another station broadcasting the same programme. <ul style="list-style-type: none"> • The AF and REG indicators light up. : Cancels.
PTY-STBY *2 PTY standby	OFF, PTY codes	Activates PTY Standby Reception with one of the PTY codes, [9].

*1 If the power supply is not interrupted by turning off the ignition key of your car, it is recommended that you select "OFF" to save the car's battery.

*2 Only for FM Radio Data System stations.

Indications	Item (__: Initial)	Selectable settings, [reference page]
TA VOL * ² Traffic announcement volume	VOL 00 – VOL 50 (or VOL 00 – VOL 30) * ³	[Initial: VOL 15]
P-SEARCH * ² Programme search	<ul style="list-style-type: none"> • ON • OFF 	<ul style="list-style-type: none"> : Activates Programme Search, [9]. : Cancels.
DIMMER Dimmer	<ul style="list-style-type: none"> • ON • OFF 	<ul style="list-style-type: none"> : Dims the display and button illumination. : Cancels.
TEL Telephone muting	<ul style="list-style-type: none"> • MUTING 1/ MUTING 2 • OFF 	<ul style="list-style-type: none"> : Select either one which mutes the sounds while using a cellular phone. : Cancels.
SCROLL * ⁴ Scroll	<ul style="list-style-type: none"> • ONCE • AUTO • OFF 	<ul style="list-style-type: none"> : Scrolls the displayed information once. : Repeats scrolling (at 5-second intervals). : Cancels. • Pressing DISP for more than one second can scroll the display regardless of the setting.
AUX ADJ Auxiliary input level adjustment	A.ADJ 00 — A.ADJ 05	: Adjust the auxiliary input level to avoid the sudden increase of the output level when changing the source from external component connected to the AUX input jack on the control panel.
AMP GAIN Amplifier gain control	<ul style="list-style-type: none"> • LOW PWR • HIGH PWR 	<ul style="list-style-type: none"> : VOL 00 – VOL 30 (Select this if the maximum power of the speaker is less than 50 W to prevent damaging the speaker.) : VOL 00 – VOL 50
IF BAND Intermediate frequency band	<ul style="list-style-type: none"> • AUTO • WIDE 	<ul style="list-style-type: none"> : Increases the tuner selectivity to reduce interference noise between close stations. (Stereo effect may be lost.) : Subject to the interference noise from adjacent stations, but sound quality will not be degraded and the stereo effect will remain.

*² Only for FM Radio Data System stations.

*³ Depends on the amplifier gain control.

*⁴ Some characters or symbols will not be shown correctly (or will be blanked) on the display.

Other external component operations

You can connect an external component to the AUX (auxiliary) input jack on the control panel.

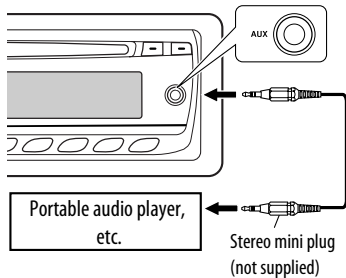

1



2

Turn on the connected component and start playing the source.

3

Adjust the volume.

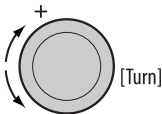

4

Adjust the sound as you want.
(See pages 11 and 12.)

To check the clock time while listening to an external component



AUX IN ↔ Clock

Maintenance

How to clean the connectors

Frequent detachment will deteriorate the connectors. To minimize this possibility, periodically wipe the connectors with a cotton swab or cloth moistened with alcohol, being careful not to damage the connectors.

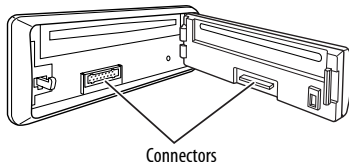

Moisture condensation

Moisture may condense on the lens inside the unit in the following cases:

- After starting the heater in the car.
 - If it becomes very humid inside the car.
- Should this occur, the unit may malfunction. In this case, eject the disc and leave the unit turned on for a few hours until the moisture has evaporated.

How to handle discs

When removing a disc from its case, press down the center holder of the case and lift the disc out, holding it by the edges.



- Always hold the disc by the edges. Do not touch its recording surface.

When storing a disc in its case, gently insert the disc around the center holder (with the printed surface facing up).

- Make sure to store discs in cases after use.

Continued on the next page

To keep discs clean

A dirty disc may not play correctly.

If a disc does become dirty, wipe it with a soft cloth in a straight line from center to edge.



- Do not use any solvents (for example, conventional record cleaner, spray, thinner, benzine, etc.) to clean discs.

To play new discs

New discs may have some rough spots around the inner and outer edges. If such a disc is used, this unit may reject the disc.



To remove these rough spots, rub the edges with a pencil or ball-point pen, etc.

Do not use the following discs:

Single CD (8 cm disc)



Warped disc



Sticker and sticker residue



Stick-on label



Unusual shape



C-thru Disc (semi-transparent disc)



Transparent or semi-transparent parts on its recording area



More about this unit

Basic operations

Turning on the power

- By pressing SRC on the unit, you can also turn on the power. If the source is ready, playback also starts.

Turning off the power

- If you turn off the power while listening to a disc, disc play will start from where it had been stopped previously next time you turn on the power.

Tuner operations

Storing stations in memory

- During SSM search...
 - All previously stored stations are erased and the stations are stored anew.
 - Received stations are preset in No. 1 (lowest frequency) to No. 6 (highest frequency).
 - When SSM is over, the station stored in No. 1 will be automatically tuned in.
- When storing a station manually, the previously preset station is erased when a new station is stored in the same preset number.

FM Radio Data System operations

- Network-Tracking Reception requires two types of Radio Data System signals—PI (Programme Identification) and AF (Alternative Frequency) to work correctly. Without receiving these data correctly, Network-Tracking Reception will not operate correctly.
- If a Traffic Announcement is received by TA Standby Reception, the volume level automatically changes to the preset level (TA VOL) if the current level is lower than the preset level.
- When Alternative Frequency Reception is activated (with AF selected), Network-Tracking Reception is also activated automatically. On the other hand, Network-Tracking Reception cannot be deactivated without deactivating Alternative Frequency Reception. (See page 13.)

Disc operations

Caution for DualDisc playback

- The Non-DVD side of a “DualDisc” does not comply with the “Compact Disc Digital Audio” standard. Therefore, the use of Non-DVD side of a DualDisc on this product may not be recommended.

General

- This unit has been designed to reproduce CDs/ CD Texts, and CD-Rs (Recordable)/CD-RWs (Rewritable) in audio CD (CD-DA) formats.

Playing a CD-R or CD-RW

- Use only “finalized” CD-Rs or CD-RWs.
- This unit can play back multi-session discs; however, unclosed sessions will be skipped while playing.
- Some CD-Rs or CD-RWs may not be played back on this unit because of their disc characteristics, or for the following reasons:
 - Discs are dirty or scratched.
 - Moisture condensation has occurred on the lens inside the unit.
 - The pickup lens inside the unit is dirty.
 - The files on the CD-R/CD-RW are written using the “Packet Write” method.
 - There are improper recording conditions (missing data, etc.) or media conditions (stained, scratched, warped, etc.).
- CD-RWs may require a longer readout time since the reflectance of CD-RWs is lower than that of regular CDs.
- Do not use the following CD-Rs or CD-RWs:
 - Discs with stickers, labels, or protective seal stuck to the surface.
 - Discs on which labels can be directly printed by an ink jet printer.

Using these discs under high temperature or high humidity may cause malfunctions or damage to the unit.

Changing the source

- If you change the source, playback also stops (without ejecting the disc). Next time you select “CD” for the playback source, disc play starts from where it has been stopped previously.

Ejecting a disc

- If the ejected disc is not removed within 15 seconds, it is automatically inserted into the loading slot again to protect it from dust.
- After ejecting a disc, “NO DISC” appears and you cannot operate some of the buttons. Insert another disc or press SRC to select another playback source.

General settings—PSM

- If you change the “AMP GAIN” setting from “HIGH PWR” to “LOW PWR” while the volume level is set higher than “VOL 30,” the unit automatically changes the volume level to “VOL 30.”

Troubleshooting

What appears to be trouble is not always serious. Check the following points before calling a service center.

	Symptoms	Remedies/Causes
General	<ul style="list-style-type: none"> • Sound cannot be heard from the speakers. 	<ul style="list-style-type: none"> • Adjust the volume to the optimum level. • Check the cords and connections.
	<ul style="list-style-type: none"> • The unit does not work at all. 	Reset the unit (see page 2).
FM/AM	<ul style="list-style-type: none"> • SSM automatic presetting does not work. 	Store stations manually.
	<ul style="list-style-type: none"> • Static noise while listening to the radio. 	Connect the aerial firmly.
Disc playback	<ul style="list-style-type: none"> • Disc cannot be played back. 	Insert the disc correctly.
	<ul style="list-style-type: none"> • CD-R/CD-RW cannot be played back. • Tracks on the CD-R/CD-RW cannot be skipped. 	<ul style="list-style-type: none"> • Insert a finalized CD-R/CD-RW. • Finalize the CD-R/CD-RW with the component which you used for recording.
	<ul style="list-style-type: none"> • Disc can be neither played back nor ejected. 	<ul style="list-style-type: none"> • Unlock the disc (see page 10). • Eject the disc forcibly (see page 2).
	<ul style="list-style-type: none"> • Disc sound is sometimes interrupted. 	<ul style="list-style-type: none"> • Stop playback while driving on rough roads. • Change the disc. • Check the cords and connections.
	<ul style="list-style-type: none"> • "NO DISC" appears on the display. • "PLEASE" and "EJECT" appear alternately on the display. 	Insert a playable disc into the loading slot.

Specifications

AUDIO AMPLIFIER SECTION	
Maximum Power Output:	
Front/Rear:	50 W per channel
Continuous Power Output (RMS):	
Front/Rear:	19 W per channel into 4 Ω , 40 Hz to 20 000 Hz at no more than 0.8% total harmonic distortion.
Load Impedance:	4 Ω (4 Ω to 8 Ω allowance)
Tone Control Range:	
Bass:	± 12 dB at 100 Hz
Treble:	± 12 dB at 10 kHz
Frequency Response:	40 Hz to 20 000 Hz
Signal-to-Noise Ratio:	70 dB
Line-Out Level/Impedance:	2.5 V/20 k Ω load (full scale)
Output Impedance:	1 k Ω
Other Terminal:	AUX (auxiliary) input jack

TUNER SECTION	
Frequency Range:	
FM:	87.5 MHz to 108.0 MHz
AM:	MW: 522 kHz to 1 620 kHz LW: 144 kHz to 279 kHz
FM Tuner	
Usable Sensitivity:	11.3 dBf (1.0 μ V/75 Ω)
50 dB Quieting Sensitivity:	16.3 dBf (1.8 μ V/75 Ω)
Alternate Channel Selectivity (400 kHz):	65 dB
Frequency Response:	40 Hz to 15 000 Hz
Stereo Separation:	30 dB
MW Tuner	
Sensitivity/Selectivity:	20 μ V/35 dB
LW Tuner	
Sensitivity:	50 μ V

CD PLAYER SECTION	
Type:	Compact disc player
Signal Detection System:	Non-contact optical pickup (semiconductor laser)
Number of Channels:	2 channels (stereo)
Frequency Response:	5 Hz to 20 000 Hz
Dynamic Range:	93 dB
Signal-to-Noise Ratio:	98 dB
Wow and Flutter:	Less than measurable limit

GENERAL	
Power Requirement:	
Operating Voltage:	DC 14.4 V (11 V to 16 V allowance)
Grounding System:	Negative ground
Allowable Operating Temperature:	0°C to +40°C
Dimensions (W \times H \times D): (approx.)	
Installation Size:	182 mm \times 52 mm \times 160 mm
Panel Size:	188 mm \times 58 mm \times 13 mm
Mass:	1.3 kg (excluding accessories)

Design and specifications are subject to change without notice.

Having TROUBLE with operation?

Please reset your unit

Refer to page of How to reset your unit

Vous avez des PROBLÈMES de fonctionnement?

Réinitialisez votre appareil

Référez-vous à la page intitulée Comment réinitialiser votre appareil

Dear Customer,

This apparatus is in conformance with the valid European directives and standards regarding electromagnetic compatibility and electrical safety.

European representative of Victor Company of Japan, Limited is:

JVC Technical Services Europe GmbH

Postfach 10 05 04

61145 Friedberg

Germany

Cher(e) client(e),

Cet appareil est conforme aux directives et normes européennes en vigueur concernant la compatibilité électromagnétique et à la sécurité électrique.

Représentant européen de la société Victor Company of Japan, Limited:

JVC Technical Services Europe GmbH

Postfach 10 05 04

61145 Friedberg

Allemagne

JVC



EN, FR

© 2008 Victor Company of Japan, Limited

0808DTSMDTJEIN

JVC KD-R201

Installation/Connection Manual

Manuel d'installation/raccordement

GET0583-010A
[EX]

0808DTSMDTJEIN
EN, FR

© 2008 Victor Company of Japan, Limited

ENGLISH

This unit is designed to operate on **12 V DC, NEGATIVE ground electrical systems**. If your vehicle does not have this system, a voltage inverter is required, which can be purchased at JVC IN-CAR ENTERTAINMENT dealers.

WARNINGS

To prevent short circuits, we recommend that you disconnect the battery's negative terminal and make all electrical connections before installing the unit.

- **Be sure to ground this unit to the car's chassis again after installation.**

Notes:

- Replace the fuse with one of the specified rating. If the fuse blows frequently, consult your JVC IN-CAR ENTERTAINMENT dealer.
- It is recommended to connect to the speakers with maximum power of more than 50 W (both at the rear and at the front, with an impedance of **4 Ω to 8 Ω**). If the maximum power is less than 50 W, change "AMP GAIN" setting to prevent the speakers from being damaged (see page 14 of the INSTRUCTIONS).
- To prevent short-circuit, cover the terminals of the UNUSED leads with insulating tape.
- The heat sink becomes very hot after use. Be careful not to touch it when removing this unit.

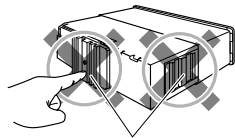

Heat sink
Dissipateur de chaleur

FRANÇAIS

Cet appareil est conçu pour fonctionner sur des sources de **courant continu de 12 V à masse NEGATIVE**. Si votre véhicule n'offre pas ce type d'alimentation, il vous faut un convertisseur de tension, que vous pouvez acheter chez un revendeur d'autoradios JVC.

AVERTISSEMENTS

Pour éviter tout court-circuit, nous vous recommandons de débrancher la borne négative de la batterie et d'effectuer tous les raccordements électriques avant d'installer l'appareil.

- **Assurez-vous de raccorder de nouveau la mise à la masse de cet appareil au châssis de la voiture après l'installation.**

Remarques:

- Remplacer le fusible par un de la valeur précisée. Si le fusible saute souvent, consulter votre revendeur d'autoradios JVC.
- Il est recommandé de connecter des enceintes avec une puissance de plus de 50 W (les enceintes arrière et les enceintes avant, avec une impédance comprise entre **4 Ω et 8 Ω**). Si la puissance maximum est inférieure à 50 W, changez "AMP GAIN" pour éviter d'endommager vos enceintes (voir page 14 du MANUEL D'INSTRUCTIONS).
- Pour éviter les court-circuits, couvrir les bornes des fils qui ne sont PAS UTILISÉS avec de la bande isolante.
- Le dissipateur de chaleur devient très chaud après usage. Faire attention de ne pas le toucher en retirant cet appareil.

PRECAUTIONS on power supply and speaker connections:

- **DO NOT connect the speaker leads of the power cord to the car battery; otherwise, the unit will be seriously damaged.**
- BEFORE connecting the speaker leads of the power cord to the speakers, check the speaker wiring in your car.

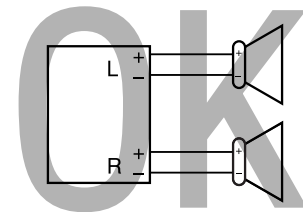
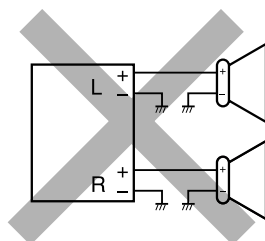
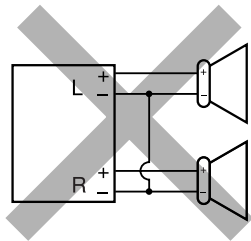

PRECAUTIONS sur l'alimentation et la connexion des enceintes:

- **NE CONNECTEZ PAS les fils d'enceintes du cordon d'alimentation à la batterie; sinon, l'appareil serait sérieusement endommagé.**
- AVANT de connecter les fils d'enceintes du cordon d'alimentation aux enceintes, vérifiez le câblage des enceintes de votre voiture.

Parts list for installation and connection

The following parts are provided for this unit. If any item is missing, consult your JVC IN-CAR ENTERTAINMENT dealer immediately.

Liste des pièces pour l'installation et raccordement

Les pièces suivantes sont fournies avec cet appareil. Si quelque chose manquait, consultez votre revendeur autoradio JVC immédiatement.

Ⓐ
Control panel
Panneau de commande

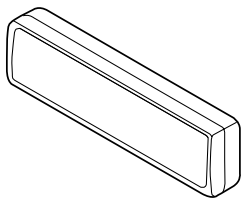

Ⓑ
Sleeve
Manchon

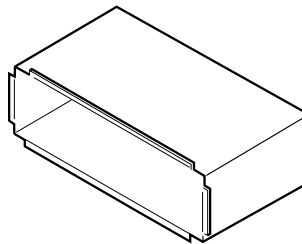

Ⓒ
Trim plate
Plaque d'assemblage

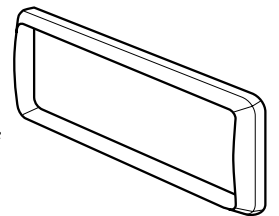

Ⓓ
Power cord
Cordon d'alimentation

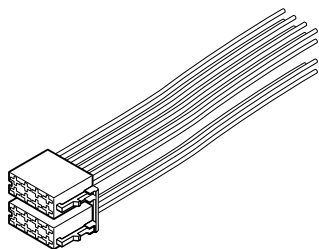

Ⓔ
Washer (ø5)
Rondelle (ø5)



Ⓕ
Lock nut (M5)
Ecrou d'arrêt (M5)



Ⓖ
Mounting bolt
(M4 × 5 mm; M5 × 12.5 mm)
Boulon de montage
(M4 × 5 mm; M5 × 12,5 mm)

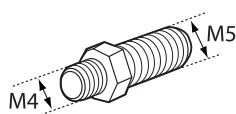

Ⓗ
Rubber cushion
Amortisseur en caoutchouc



Ⓘ
Handles
Poignées

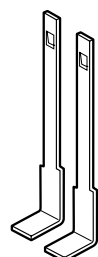

INSTALLATION (IN-DASH MOUNTING)

The following illustration shows a typical installation. If you have any questions or require information regarding installation kits, consult your JVC IN-CAR ENTERTAINMENT dealer or a company supplying kits.

- If you are not sure how to install this unit correctly, have it installed by a qualified technician.

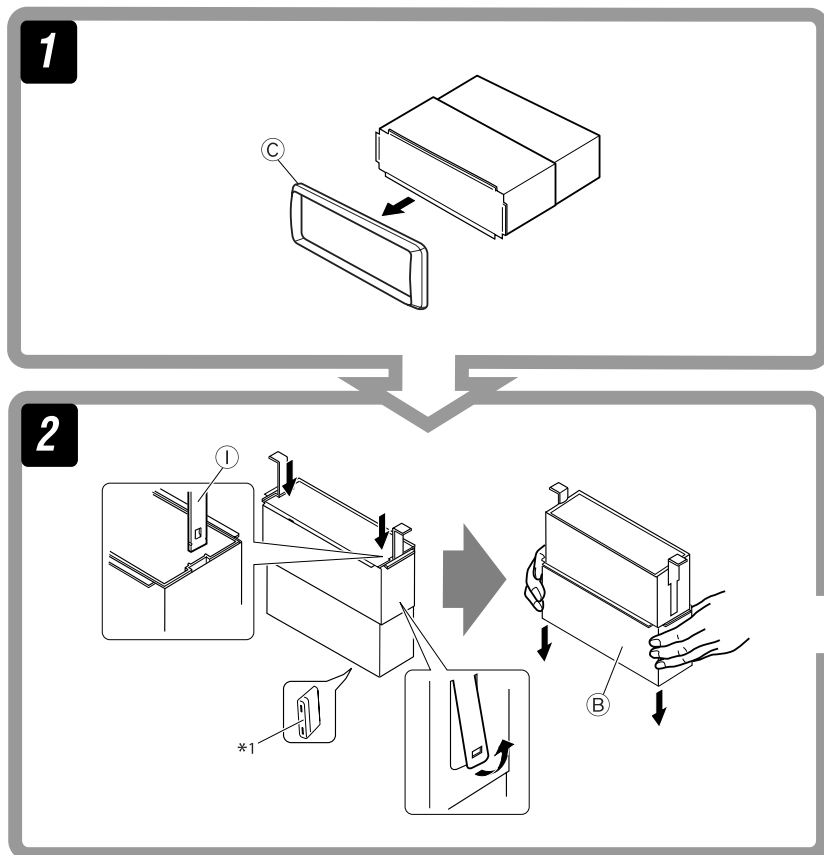

INSTALLATION (MONTAGE DANS LE TABLEAU DE BORD)

L'illustration suivante est un exemple d'installation typique. Si vous avez des questions ou avez besoin d'information sur des kits d'installation, consulter votre revendeur d'autoradios JVC ou une compagnie d'approvisionnement.

- Si l'on n'est pas sûr de pouvoir installer correctement cet appareil, le faire installer par un technicien qualifié.

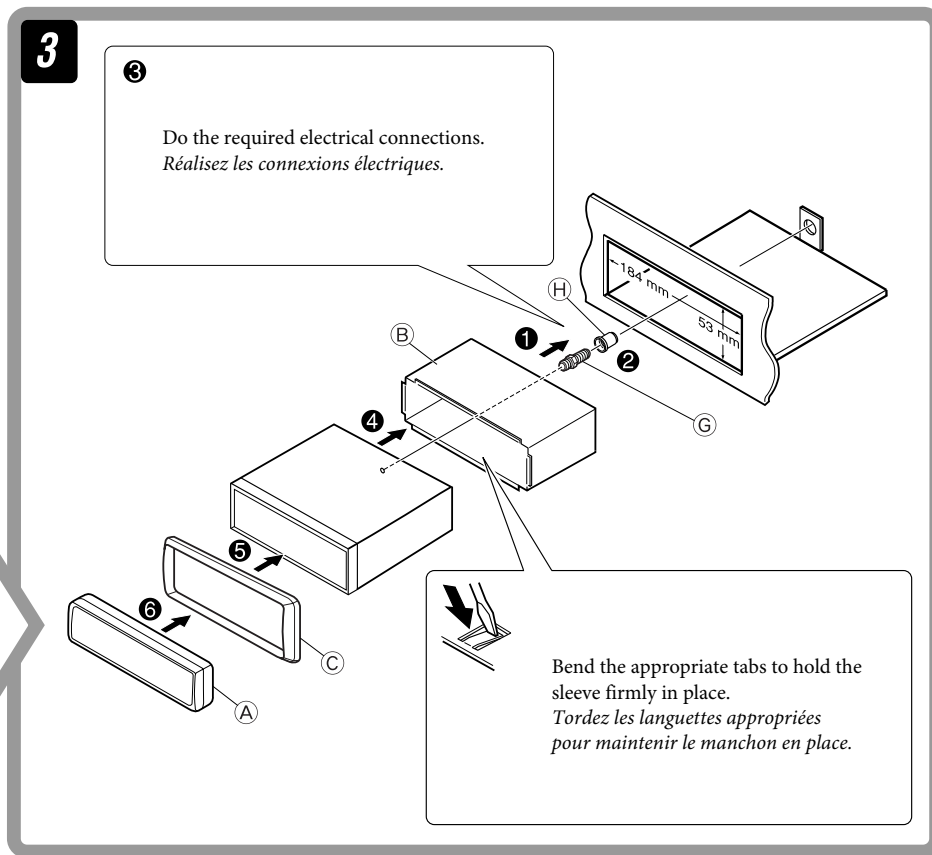

Removing the unit

Before removing the unit, release the rear section.

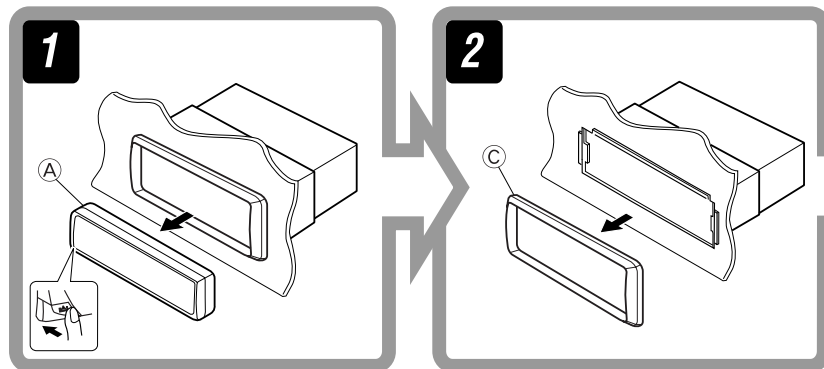

Retrait de l'appareil

Avant de retirer l'appareil, libérer la section arrière.

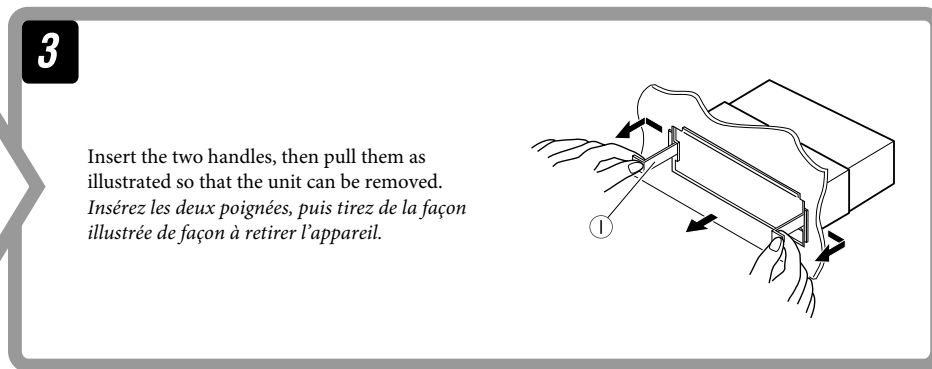

When using the optional stay / Lors de l'utilisation du hauban en option

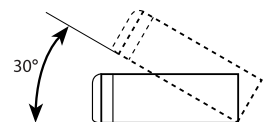
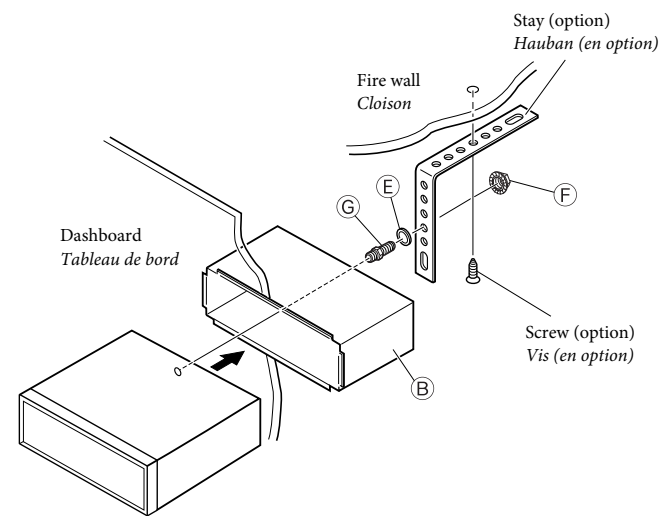

Install the unit at an angle of less than 30°.
Installez l'appareil avec un angle de moins de 30°.

When installing the unit without using the sleeve / Lors de l'installation de l'appareil sans utiliser de manchon

In a Toyota car for example, first remove the car radio and install the unit in its place.
Dans une voiture Toyota, par exemple, retirez d'abord l'autoradio et installez l'appareil à sa place.

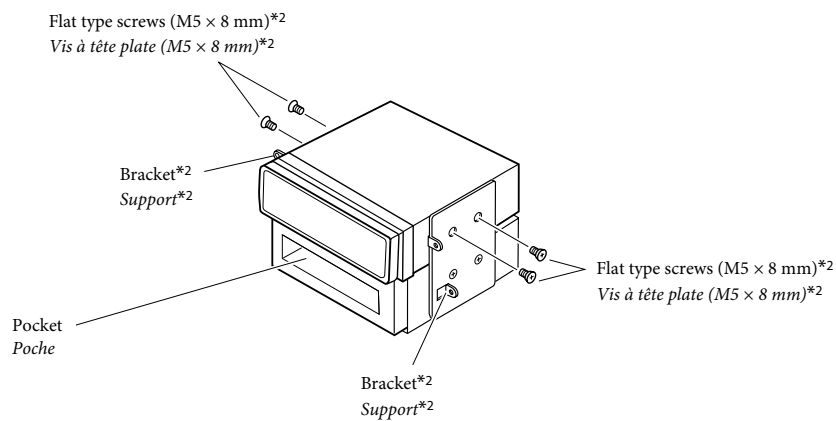

- Note** : When installing the unit on the mounting bracket, make sure to use the 8 mm-long screws. If longer screws are used, they could damage the unit.
- Remarque** : Lors de l'installation de l'appareil sur le support de montage, s'assurer d'utiliser des vis d'une longueur de 8 mm. Si des vis plus longues sont utilisées, elles peuvent endommager l'appareil.

*1 When you stand the unit, be careful not to damage the fuse on the rear.
*2 Not supplied for this unit.

*1 Lorsque vous mettez l'appareil à la verticale, faire attention de ne pas endommager le fusible situé sur l'arrière.
*2 Non fourni avec cet autoradio.

ELECTRICAL CONNECTIONS

RACCORDEMENTS ELECTRIQUES

A Typical Connections / Raccordements typiques

Before connecting: Check the wiring in the vehicle carefully. Incorrect connection may cause serious damage to this unit.
The leads of the power cord and those of the connector from the car body may be different in color.

- 1 Connect the colored leads of the power cord in the order specified in the illustration below.
- 2 Connect the aerial cord.
- 3 Finally connect the wiring harness to the unit.

Note: If your vehicle does not have any accessory terminal, move the fuse from the fuse position 1 (initial position) to fuse position 2, and connect the red lead (A7) to the positive (+) battery terminal.
• The yellow lead (A4) is not used in this case.

Avant de commencer la connexion: Vérifiez attentivement le câblage du véhicule. Une connexion incorrecte peut endommager sérieusement l'appareil.
Le fil du cordon d'alimentation et ceux des connecteurs du châssis de la voiture peuvent être différents en couleur.

- 1 Connectez les fils colorés du cordon d'alimentation dans l'ordre spécifié sur l'illustration ci-dessous.
- 2 Connectez le cordon d'antenne.
- 3 Finalement, connectez le faisceau de fils à l'appareil.

Remarque: Si votre véhicule ne possède pas de borne accessoire, déplacez le fusible de la position de fusible 1 (position originale) à la position de fusible 2 et connectez le fil rouge (A7) à la borne positive (+) de la batterie.
• Le fil jaune (A4) n'est pas utilisé dans ce cas.

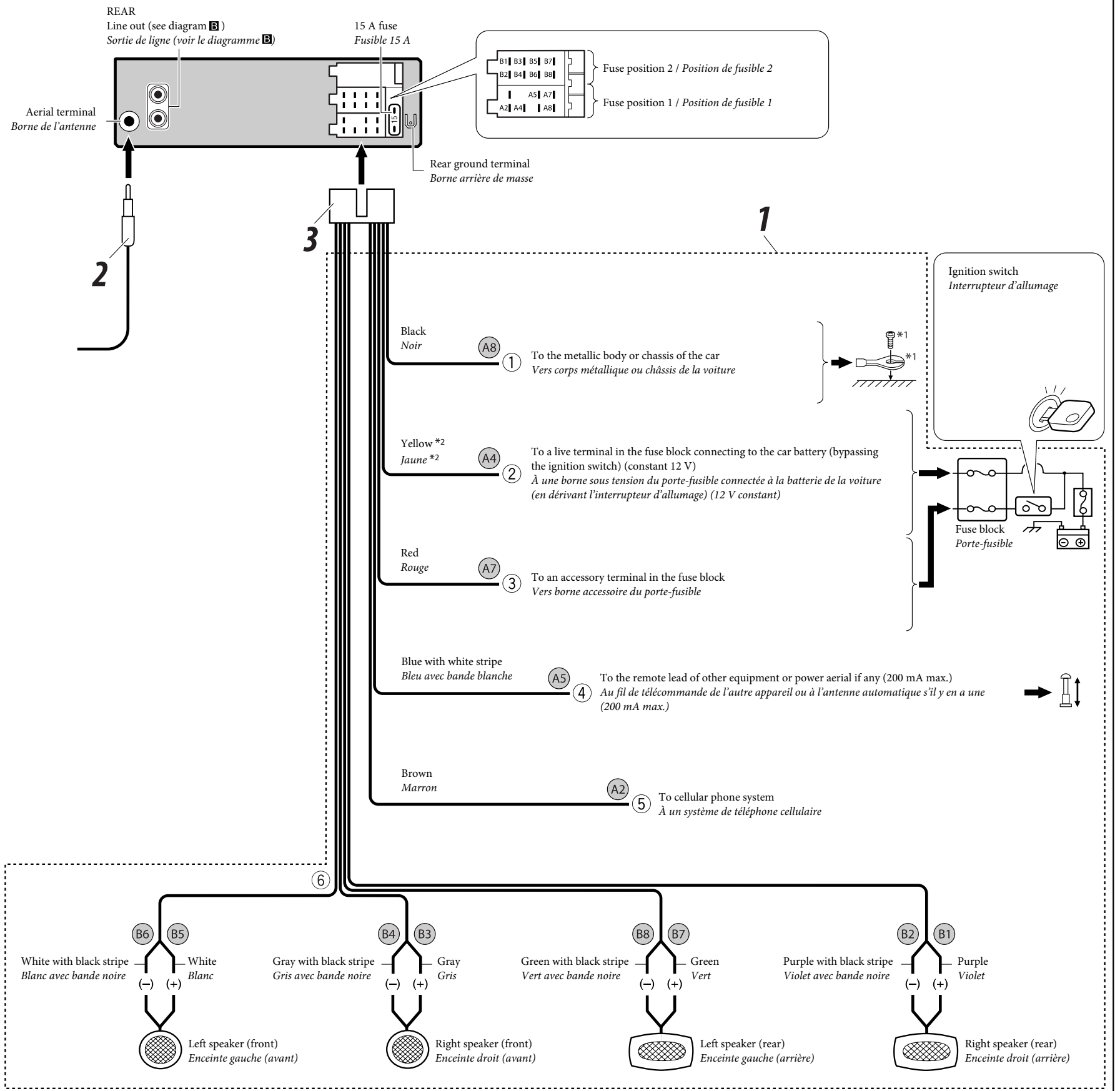

*1 Not supplied for this unit.
*2 Before checking the operation of this unit prior to installation, this lead must be connected; otherwise, the power cannot be turned on.

*1 Non fourni avec cet autoradio.
*2 Pour vérifier le fonctionnement de cet appareil avant installation, ce fil doit être raccordé, sinon l'appareil ne peut pas être mis sous tension.

B Connecting the external amplifier / Connexion d'un amplificateur extérieur

You can connect an amplifier to upgrade your car stereo system.

- Connect the remote lead (blue with white stripe) to the remote lead of the other equipment so that it can be controlled through this unit.
- **Disconnect the speakers from this unit, connect them to the amplifier. Leave the speaker leads of this unit unused.**

Vous pouvez connecter un amplificateur pour améliorer votre système autoradio.

- Connectez le fil de commande à distance (bleu avec bande blanche) au fil de commande à distance de l'autre appareil de façon qu'il puisse être commandé via cet appareil.
- **Déconnectez les enceintes de cet appareil et connectez-les à l'amplificateur. Laissez les fils d'enceintes de cet appareil inutilisés.**

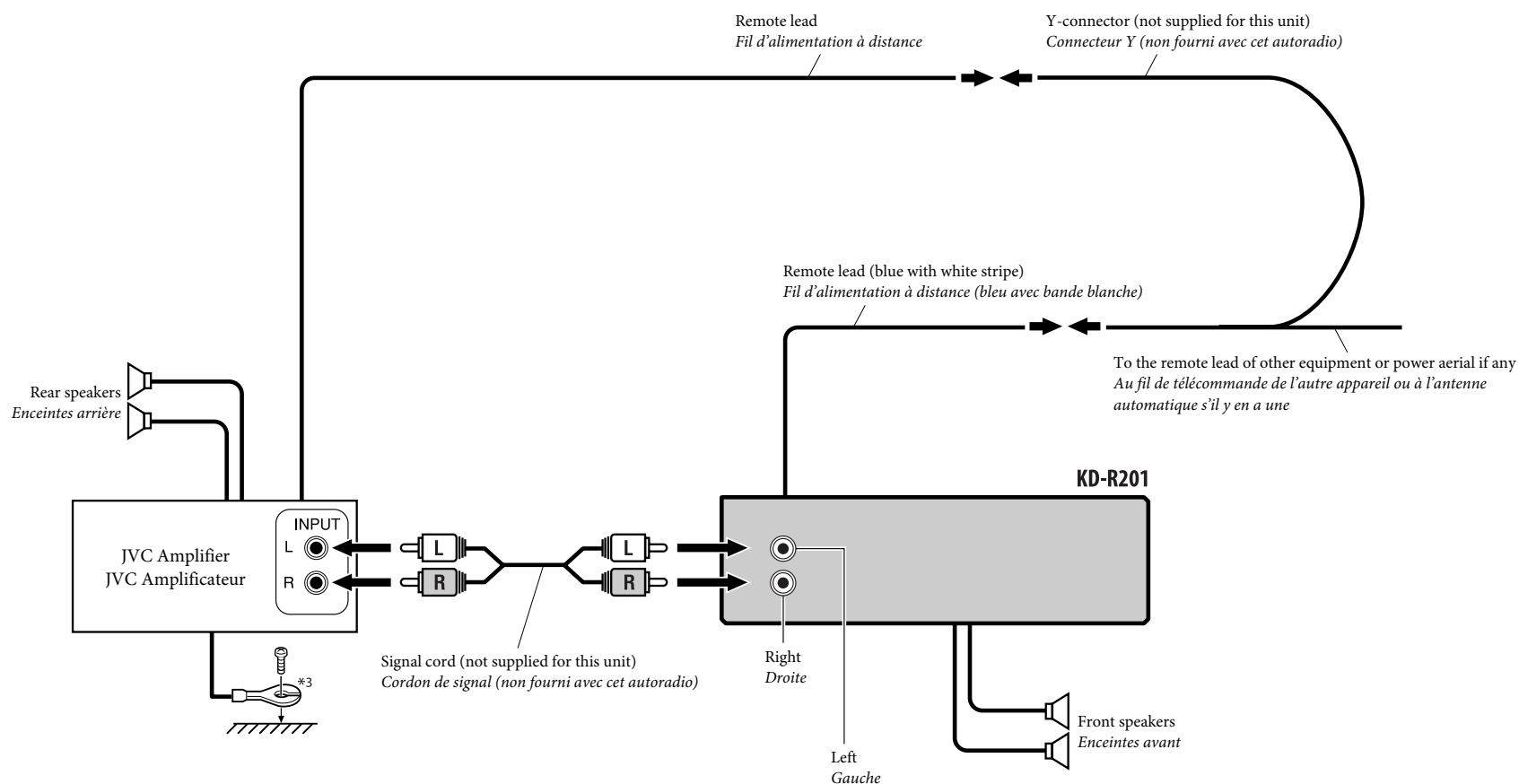

*3 Firmly attach the ground wire to the metallic body or to the chassis of the car—to the place not coated with paint (if coated with paint, remove the paint before attaching the wire). Failure to do so may cause damage to the unit.

*3 Attachez solidement le fil de mise à la masse au châssis métallique de la voiture—à un endroit qui n'est pas recouvert de peinture (s'il est recouvert de peinture, enlevez d'abord la peinture avant d'attacher le fil). L'appareil peut être endommagé si cela n'est pas fait correctement.

TROUBLESHOOTING

• The fuse blows.

* Are the red and black leads connected correctly?

• Power cannot be turned on.

* Is the yellow lead connected?

• No sound from the speakers.

* Is the speaker output lead short-circuited?

• Sound is distorted.

* Is the speaker output lead grounded?

* Are the “-” terminals of L and R speakers grounded in common?

• Noise interferes with sounds.

* Is the rear ground terminal connected to the car's chassis using shorter and thicker cords?

• This unit becomes hot.

* Is the speaker output lead grounded?

* Are the “-” terminals of L and R speakers grounded in common?

• This unit does not work at all.

* Have you reset your unit?

EN CAS DE DIFFICULTES

• Le fusible saute.

* Les fils rouge et noir sont-ils raccordés correctement?

• L'appareil ne peut pas être mise sous tension.

* Le fil jaune est-elle raccordée?

• Pas de son des enceintes.

* Le fil de sortie d'enceinte est-il court-circuité?

• Le son est déformé.

* Le fil de sortie d'enceinte est-il à la masse?

* Les bornes “-” des enceintes gauche et droit sont-elles mises ensemble à la masse?

• Interférence avec les sons.

* La prise arrière de mise à la terre est-elle connectée au châssis de la voiture avec un cordon court et épais?

• L'appareil devient chaud.

* Le fil de sortie d'enceinte est-il à la masse?

* Les bornes “-” des enceintes gauche et droit sont-elles mises ensemble à la masse?

• Cet appareil ne fonctionne pas du tout.

* Avez-vous réinitialisé votre appareil?

JVC

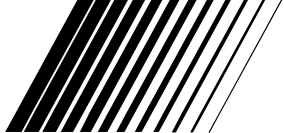

ENGLISH

DEUTSCH

РУССКИЙ

ΕΛΛΗΝΙΚΑ

CD RECEIVER

CD-RECEIVER

РЕСИВЕР С ПРОИГРЫВАТЕЛЕМ КОМПАКТ-ДИСКОВ

ΔΕΚΤΗΣ ΜΕ CD

KD-R203/KD-R201

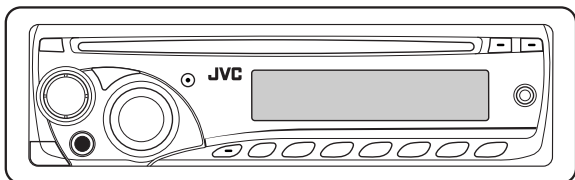
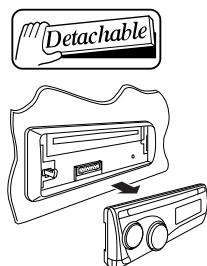

Radio Data System



For KD-R203
MP3 WMA

For canceling the display demonstration, see page 5.

Zum Abbrechen der Displaydemonstration siehe Seite 5.

Информация об отмене демонстрации функций дисплея см. на стр. 5.

Για να ακυρώσετε την επίδειξη λειτουργίας στην οθόνη, βλ. σελίδα 5.

For installation and connections, refer to the separate manual.

Für den Einbau und die Anschlüsse siehe das eigenständige Handbuch.

Указания по установке и выполнению соединений приводятся в отдельной инструкции.

Για πληροφορίες σχετικά με την εγκατάσταση και τις συνδέσεις, ανατρέξτε στο αντίστοιχο ξεχωριστό εγχειρίδιο.

INSTRUCTIONS

BEDIENUNGSANLEITUNG
ИНСТРУКЦИИ ПО ЭКСПЛУАТАЦИИ
ΟΔΗΓΙΕΣ

GET0583-006A
[EY]



Thank you for purchasing a JVC product.

Please read all instructions carefully before operation, to ensure your complete understanding and to obtain the best possible performance from the unit.

IMPORTANT FOR LASER PRODUCTS

1. CLASS 1 LASER PRODUCT
2. **CAUTION:** Do not open the top cover. There are no user serviceable parts inside the unit; leave all servicing to qualified service personnel.
3. **CAUTION:** Visible and/or invisible class 1M laser radiation when open. Do not view directly with optical instruments.
4. REPRODUCTION OF LABEL: CAUTION LABEL, PLACED OUTSIDE THE UNIT.

CAUTION VISIBLE AND/OR INVISIBLE CLASS 1M LASER RADIATION WHEN OPEN, DO NOT VIEW DIRECTLY WITH OPTICAL INSTRUMENTS. IEC80025-1:2001 (EN3)	ATTENTION RAYONNEMENT LASER VISIBLE ET/OU INVISIBLE DE CLASSE 1M UNE FOIS OUVERT NE PAS REGARDER DIRECTEMENT AVEC DES INSTRUMENTS OPTIQUES. (FRA)	AVISO RADIACION LASER DE CLASE 1M VISIBLE Y/O INVISIBLE CUANDO ESTA ABIERTO, NO MIRAR DIRECTAMENTE CON INSTRUMENTAL OPTICO. (ESP)	VARNING SYNLIG OCH/ELLER OSYNLIG LASERSTRÅLNING, KLASS 1M, NÄR DENNA DEL ÄR ÖPPNAD. BETRÄKTA EJ STRÅLEN MED OPTISKA INSTRUMENT. (SWE)	注意 ここを開くと可視 及び/または不可視 のクラス1M レーザー放射が 出ます。 光学機器で直接 見ないでください。 (JPN)	CAUTION VISIBLE AND/OR INVISIBLE CLASS 1 LASER RADIATION WHEN OPEN, DO NOT STARE INTO BEAM. FDA 21 CFR (EN3)
--	--	--	--	--	---

Warning:

If you need to operate the unit while driving, be sure to look around carefully or you may be involved in a traffic accident.

How to reset your unit

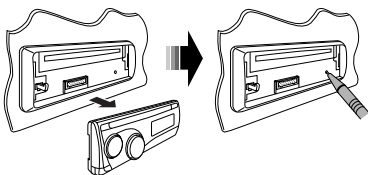

- Your preset adjustments will also be erased.

How to forcibly eject a disc



- Be careful not to drop the disc when it ejects.
- If this does not work, reset your unit.

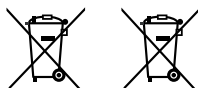

Battery
Products

Information for Users on Disposal of Old Equipment and Batteries

[European Union only]

These symbols indicate that the product and the battery with this symbol should not be disposed as general household waste at its end-of-life.

If you wish to dispose of this product and the battery, please do so in accordance with applicable national legislation or other rules in your country and municipality.

By disposing of this product correctly, you will help to conserve natural resources and will help prevent potential negative effects on the environment and human health.

Notice:

The sign Pb below the symbol for batteries indicates that this battery contains lead.

How to use the M MODE button

If you press M MODE, the unit goes into functions mode, then the number buttons and ▲ / ▼ buttons will work as different function buttons.

Ex.: When number button 2 works as MO (monaural) button.



To use these buttons for their original functions again after pressing M MODE, wait for 5 seconds without pressing any of these buttons until the functions mode is cleared, or press M MODE again.

Detaching the control panel

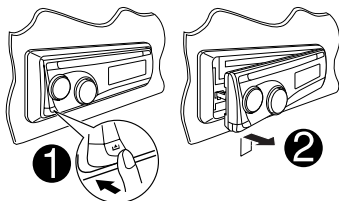

Attaching the control panel

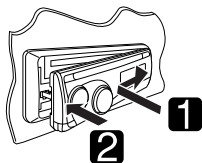

Caution on volume setting:

Discs produce very little noise compared with other sources. Lower the volume before playing a disc to avoid damaging the speakers by the sudden increase of the output level.

CONTENTS

Control panel	4
Getting started.....	5
Basic operations.....	5
Radio operations	6
FM Radio Data System operations.....	7
Searching for your favorite FM Radio Data System programme.....	7
Disc operations.....	9
Playing a disc in the unit	9
Sound adjustments.....	11
General settings — PSM.....	12
Other external component operations	15
Maintenance	15
More about this unit	16
Troubleshooting.....	18
Specifications.....	19

For safety...

- Do not raise the volume level too much, as this will block outside sounds, making driving dangerous.
- Stop the car before performing any complicated operations.

Temperature inside the car...

If you have parked the car for a long time in hot or cold weather, wait until the temperature in the car becomes normal before operating the unit.

Control panel

Parts identification

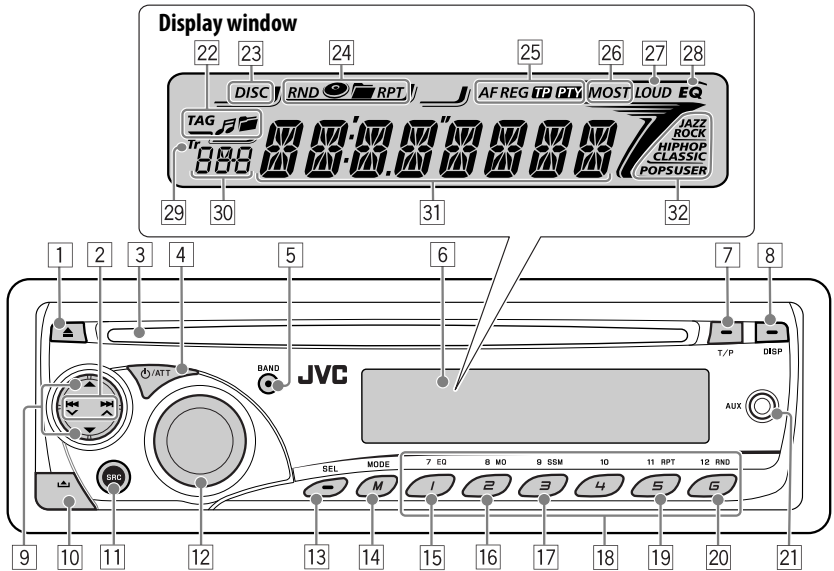

- | | |
|--|--|
| 1 ▲ (eject) button | 21 AUX (auxiliary) input jack |
| 2 ◀◀◀ / ▶▶▶ / ▲ buttons | 22 Disc information indicators—
TAG* (Tag information), 🎵 (track/file),
📁* (folder) |
| 3 Loading slot | 23 DISC indicator |
| 4 ⏻/ATT (standby/attenuator) button | 24 Playback mode / item indicators—RND (random),
🎵 (disc), 📁* (folder), RPT (repeat) |
| 5 BAND button | 25 Radio Data System indicators—AF, REG, TP, PTY |
| 6 Display window | 26 Tuner reception indicators—MO (monaural),
ST (stereo) |
| 7 T/P (traffic programme/programme type) button | 27 LOUD (loudness) indicator |
| 8 DISP (display) button | 28 EQ (equalizer) indicator |
| 9 ▲ (up)/▼ (down) buttons | 29 Tr (track) indicator |
| 10 📄 (control panel release) button | 30 Source display / Track number / Volume level
indicator / Time countdown indicator |
| 11 SRC (source) button | 31 Main display |
| 12 Control dial | 32 Sound mode (c-EQ: custom equalizer) indicators—
JAZZ, ROCK, HIP HOP, CLASSIC, POPS, USER |
| 13 SEL (select) button | |
| 14 M MODE button | |
| 15 EQ (equalizer) button | |
| 16 MO (monaural) button | |
| 17 SSM (Strong-station Sequential Memory) button | |
| 18 Number buttons | |
| 19 RPT (repeat) button | |
| 20 RND (random) button | |

* For KD-R203

Getting started

Basic operations

- 1 Turn on the power.



- 2  → FM1/FM2/FM3/AM
AUX IN ← CD*

* You cannot select "CD" as the playback source if there is no disc in the unit.



- 3 For FM/AM tuner

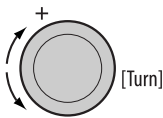

- 4 Adjust the volume.



- 5 Adjust the sound as you want. (See pages 11 and 12.)

<p>To drop the volume in a moment (ATT) To restore the sound, press the button again.</p>	
<p>To turn off the power</p>	 [Hold]

Basic settings

- See also "General settings — PSM" on pages 12 – 14.

- 1  [Hold]

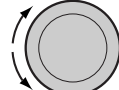
- 2  →  [Turn]

- 1 **Canceling the display demonstrations**
Select "DEMO," then "DEMO OFF."

- 2 **Setting the clock**

Select "CLOCK H" (hour), then adjust the hour.
Select "CLOCK M" (minute), then adjust the minute.

Select "24H/12H," then "24H" (hour) or "12H" (hour).

- 3 Finish the procedure.



To check the current clock time while the power is turned off



Clock time is shown on the display for about 5 seconds. See also page 13.

Radio operations



Lights up when receiving an FM stereo broadcast with sufficient signal strength.



3 Start searching for a station.



When a station is received, searching stops.
To stop searching, press the same button again.

To tune in to a station manually

In step 3 above...

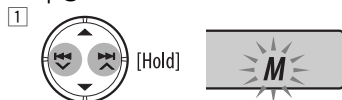

2 Select a desired station frequency.



When an FM stereo broadcast is hard to receive



Lights up when monaural mode is activated.



Reception improves, but the stereo effect will be lost.

To restore the stereo effect, repeat the same procedure. "MONO OFF" appears and the MO indicator goes off.

Storing stations in memory

You can preset six stations for each band.

FM station automatic presetting—SSM (Strong-station Sequential Memory)

1 Select the FM band (FM1 – FM3) you want to store into.





"SSM" flashes, then disappears when automatic presetting is over.

Local FM stations with the strongest signals are searched and stored automatically in the FM band.

Manual presetting

Ex.: Storing the FM station of 92.5 MHz into preset number 4 of the FM1 band.

- 

FM1 → FM2 → FM3
AM ←
- 
- 

[Hold]

Preset number flashes for a while.

Listening to a preset station

- 

FM1 → FM2 → FM3
AM ←
- Select the preset station (1 – 6) you want.



To check the current clock time while listening to an FM (non-Radio Data System) or AM station

- For FM Radio Data System stations, see page 9.



Frequency ↔ Clock

FM Radio Data System operations

What you can do with Radio Data System

Radio Data System allows FM stations to send an additional signal along with their regular programme signals.

By receiving the Radio Data System data, this unit can do the following:

- Programme Type (PTY) Search (see the following)
- TA (Traffic Announcement) and PTY Standby Receptions (see pages 8, 9, 13 and 14)
- Tracing the same programme automatically —Network-Tracking Reception (see page 9)
- Programme Search (see pages 9 and 14)

Searching for your favorite FM Radio Data System programme

You can tune in to a station broadcasting your favorite programme by searching for a PTY code.

- To store your favorite programme types, see page 8.

-  [Hold] The last selected PTY code appears.

- Select one of your favorite programme types.



or

Select one of the PTY codes (see page 9).

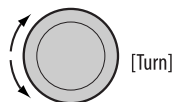

Continued on the next page

3 Start searching for your favorite programme.



If there is a station broadcasting a programme of the same PTY code as you have selected, that station is tuned in.

Storing your favorite programme types

You can store six favorite programme types.

Preset programme types in the number buttons (1 to 6):

1	2	3	4	5	6
POP M	ROCK M	EASY M	CLASSICS	AFFAIRS	VARIED

1 Select a PTY code (see pages 7 and 8).

2 Select the preset number (1 – 6) you want to store into.

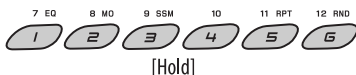

Ex.: When "ROCK M" is selected

3 Repeat steps 1 and 2 to store other PTY codes into other preset numbers.

4 Finish the procedure.



Using the standby receptions

TA Standby Reception

TA Standby Reception allows the unit to switch temporarily to Traffic Announcement (TA) from any source other than AM.

The volume changes to the preset TA volume level if the current level is lower than the preset level (see page 14).

To activate TA Standby Reception



The TP (Traffic Programme) indicator either lights up or flashes.

- If the TP indicator lights up, TA Standby Reception is activated.
- If the TP indicator flashes, TA Standby Reception is not yet activated. (This occurs when you are listening to an FM station without the Radio Data System signals required for TA Standby Reception.) To activate TA Standby Reception, tune in to another station providing these signals. The TP indicator will stop flashing and remain lit.

To deactivate the TA Standby Reception



The TP indicator goes off.

PTY Standby Reception

PTY Standby Reception allows the unit to switch temporarily to your favorite PTY programme from any source other than AM.

To activate and select your favorite PTY code for PTY Standby Reception, see page 13.

The PTY indicator either lights up or flashes.

- If the PTY indicator lights up, PTY Standby Reception is activated.
- If the PTY indicator flashes, PTY Standby Reception is not yet activated.

To activate PTY Standby Reception, tune in to another station providing these signals. The PTY indicator will stop flashing and remain lit.

To deactivate the **PTY Standby Reception**, select "OFF" for the PTY code (see page 13). The PTY indicator goes off.

Tracing the same programme— Network-Tracking Reception

When driving in an area where FM reception is not sufficient enough, this unit automatically tunes in to another FM Radio Data System station of the same network, possibly broadcasting the same programme with stronger signals (see the illustration below).

When shipped from the factory, Network-Tracking Reception is activated.

To change the **Network-Tracking Reception setting**, see "AF-REG" on page 13.

Programme A broadcasting on different frequency areas (01 – 05)

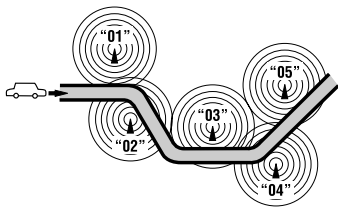

Automatic station selection— Programme Search

Usually when you press the number buttons, the preset station is tuned in.

If the signals from the FM Radio Data System preset station are not sufficient for good reception, this unit, using the AF data, tunes in to another frequency broadcasting the same programme as the original preset station is broadcasting.

- The unit takes some time to tune in to another station using programme search.
- See also page 14.

To check the current clock time while listening to an FM Radio Data System station



Station name (PS) → Station
Frequency → Programme
type (PTY) → Clock → (back to
the beginning)

PTY codes

NEWS, AFFAIRS, INFO, SPORT, EDUCATE, DRAMA, CULTURE, SCIENCE, VARIED, POP M (music), ROCK M (music), EASY M (music), LIGHT M (music), CLASSICS, OTHER M (music), WEATHER, FINANCE, CHILDREN, SOCIAL, RELIGION, PHONE IN, TRAVEL, LEISURE, JAZZ, COUNTRY, NATION M (music), OLDIES, FOLK M (music), DOCUMENT

Disc operations

Playing a disc in the unit

- 1 Turn on the power.





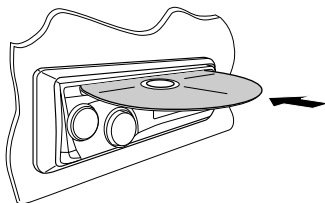

- 2



All tracks will be played repeatedly until you change the source or eject the disc.

Continued on the next page

To stop play and eject the disc • Press SRC to listen to another playback source.	
To fast-forward or reverse the track	
To go to the next or previous track	
KD-R203: To go to the next or previous folder (only for MP3 or WMA discs)	

To locate a particular track (for CD) or folder (for KD-R203: MP3 or WMA discs) directly

To select a number from 01 – 06:



To select a number from 07 – 12:

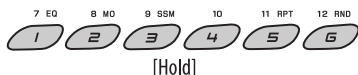

- KD-R203: To use direct folder access on MP3/WMA discs, it is required that folders are assigned with 2-digit numbers at the beginning of their folder names—01, 02, 03, and so on.

KD-R203: To select a particular track in a folder (for MP3 or WMA disc):



Other main functions

Skipping tracks quickly during play

- KD-R203: For MP3 or WMA discs, you can skip tracks within the same folder.

Ex.: To select track 32 while playing a track whose number is a single digit (1 to 9)

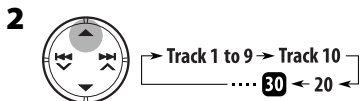

Each time you press the button, you can skip 10 tracks.

- After the last track, the first track will be selected and vice versa.



Prohibiting disc ejection

You can lock a disc in the loading slot.

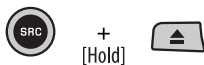

To cancel the prohibition, repeat the same procedure.

Changing the display information



While playing an audio CD or CD Text

A → B → Disc title/performer*1 → Track title*1 [🎵] → (back to the beginning)

While playing an MP3 or a WMA track (for KD-R203)

- When "TAG DISP" is set to "TAG ON" (see page 14)

A → B → Album name/performer (folder name*) [TAG] → Track title (file name*) [TAG] → (back to the beginning)

- When "TAG DISP" is set to "TAG OFF"

A → B → Folder name [] → File name [] → (back to the beginning)

- A** : The elapsed playing time with the current track number
B : Clock with the current track number
 [] : Corresponding indicator lights up on the display.

*1 If the current disc is an audio CD, "NO NAME" appears.

*2 KD-R203: If an MP3/WMA file does not have Tag information, folder name and file name appear. In this case, the TAG indicator will not light up.

Selecting the playback modes

You can use only one of the following playback modes at a time.



2 Select your desired playback mode.

- Repeat play



Mode Plays repeatedly

- TRK RPT** : The current track. [RPT]
FLDR RPT* : All tracks of the current folder. [RPT]
RPT OFF : Cancels.

- Random play



Mode Plays at random

- FLDR RND*** : All tracks of the current folder, then the tracks of the next folder and so on. [RND]
ALL RND : All tracks of the current disc. [RND]
RND OFF : Cancels.

* KD-R203: Only while playing an MP3 or a WMA disc.

[] : Corresponding indicator lights up on the display.

Sound adjustments

You can select a preset sound mode suitable to the music genre (c-EQ: custom equalizer).



Preset values	BAS (bass)	TRE (treble)	LOUD (loudness)
USER (Flat sound)	00	00	OFF
ROCK (Rock or disco music)	+03	+01	ON
CLASSIC (Classical music)	+01	-02	OFF
POPS (Light music)	+04	+01	OFF
HIP HOP (Funk or rap music)	+02	00	ON
JAZZ (Jazz music)	+02	+03	OFF

Continued on the next page

Adjusting the sound

You can adjust the sound characteristics to your preference.

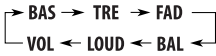
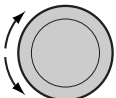
- 

-  [Turn]

Indication, [Range]

BAS*¹ (bass), [-06 to +06]
Adjust the bass.

TRE*¹ (treble), [-06 to +06]
Adjust the treble.

FAD*² (fader), [R06 to F06]
Adjust the front and rear speaker balance.

BAL (balance), [L06 to R06]
Adjust the left and right speaker balance.

LOUD*¹ (loudness), [LOUD ON or LOUD OFF]
Boost low and high frequencies to produce a well-balanced sound at a low volume level.

VOL (volume), [00 to 50 or 00 to 30]*³
Adjust the volume.



*¹ When you adjust the bass, treble, or loudness, the adjustment you have made is stored for the currently selected sound mode (c-EQ) including "USER."

*² If you are using a two-speaker system, set the fader level to "00."

*³ Depending on the amplifier gain control setting. (See page 14 for details.)

General settings — PSM

You can change PSM (Preferred Setting Mode) items listed on pages 13 and 14.

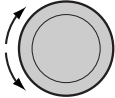
-  [Hold]
- Select a PSM item.
 
- Adjust the PSM item selected.
  [Turn]
- Repeat steps 2 and 3 to adjust other PSM items if necessary.

- Finish the procedure.



Indications	Item (__: Initial)	Selectable settings, [reference page]
DEMO Display demonstration	<ul style="list-style-type: none"> • DEMO ON • DEMO OFF 	<ul style="list-style-type: none"> : Display demonstration will be activated automatically if no operation is done for about 20 seconds, [5]. : Cancels.
CLK DISP *1 Clock display	<ul style="list-style-type: none"> • ON • OFF 	<ul style="list-style-type: none"> : Clock time is shown on the display at all times when the power is turned off. : Cancels; pressing DISP will show the clock time for about 5 seconds when the power is turned off, [5].
CLOCK H Hour adjustment	0 – 23 (1 – 12)	[Initial: 0 (0:00)], [5].
CLOCK M Minute adjustment	00 – 59	[Initial: 00 (0:00)], [5].
24H/12H Time display mode	<ul style="list-style-type: none"> • 24H • 12H 	: See also page 5 for setting.
CLK ADJ *2 Clock adjustment	<ul style="list-style-type: none"> • AUTO • OFF 	<ul style="list-style-type: none"> : The built-in clock is automatically adjusted using the CT (clock time) data in the Radio Data System signal. : Cancels.
AF-REG *2 Alternative frequency/ regionalization reception	<ul style="list-style-type: none"> • AF • AF REG • OFF 	<ul style="list-style-type: none"> : When the currently received signals become weak, the unit switches to another station (the programme may differ from the one currently received), [9, 16]. <ul style="list-style-type: none"> • The AF indicator lights up. : When the currently received signals become weak, the unit switches to another station broadcasting the same programme. <ul style="list-style-type: none"> • The AF and REG indicators light up. : Cancels.
PTY-STBY *2 PTY standby	OFF, PTY codes	Activates PTY Standby Reception with one of the PTY codes, [9].

*1 If the power supply is not interrupted by turning off the ignition key of your car, it is recommended that you select "OFF" to save the car's battery.

*2 Only for FM Radio Data System stations.

Indications	Item (__: Initial)	Selectable settings, [reference page]
TA VOL * ² Traffic announcement volume	VOL 00 – VOL 50 (or VOL 00 – VOL 30)* ³	[Initial: VOL 15]
P-SEARCH * ² Programme search	• ON • OFF	: Activates Programme Search, [9]. : Cancels.
DIMMER Dimmer	• ON • OFF	: Dims the display and button illumination. : Cancels.
TEL Telephone muting	• MUTING 1/ MUTING 2 • OFF	: Select either one which mutes the sounds while using a cellular phone. : Cancels.
SCROLL * ⁴ Scroll	• ONCE • AUTO • OFF	: Scrolls the displayed information once. : Repeats scrolling (at 5-second intervals). : Cancels. • Pressing DISP for more than one second can scroll the display regardless of the setting.
AUX ADJ Auxiliary input level adjustment	A.ADJ 00 — A.ADJ 05	: Adjust the auxiliary input level to avoid the sudden increase of the output level when changing the source from external component connected to the AUX input jack on the control panel.
TAG DISP (for KD-R203) Tag display	• TAG ON • TAG OFF	: Shows the Tag information while playing MP3/WMA tracks, [11]. : Cancels.
AMP GAIN Amplifier gain control	• LOW PWR • HIGH PWR	: VOL 00 – VOL 30 (Select this if the maximum power of the speaker is less than 50 W to prevent damaging the speaker.) : VOL 00 – VOL 50
IF BAND Intermediate frequency band	• AUTO • WIDE	: Increases the tuner selectivity to reduce interference noise between close stations. (Stereo effect may be lost.) : Subject to the interference noise from adjacent stations, but sound quality will not be degraded and the stereo effect will remain.

*² Only for FM Radio Data System stations.*³ Depends on the amplifier gain control.*⁴ Some characters or symbols will not be shown correctly (or will be blanked) on the display.

Other external component operations

You can connect an external component to the AUX (auxiliary) input jack on the control panel.

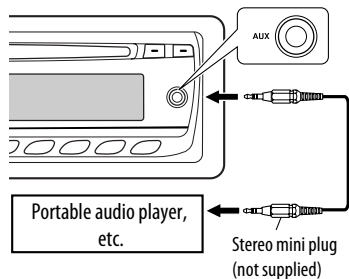

- 1  → AUX IN →
← CD ← FM1/FM2/FM3/AM ←
- 2 Turn on the connected component and start playing the source.

- 3 Adjust the volume.

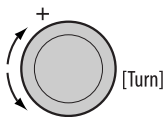

- 4 Adjust the sound as you want.
(See pages 11 and 12.)

To check the clock time while listening to an external component



AUX IN ↔ Clock

Maintenance

How to clean the connectors

Frequent detachment will deteriorate the connectors. To minimize this possibility, periodically wipe the connectors with a cotton swab or cloth moistened with alcohol, being careful not to damage the connectors.

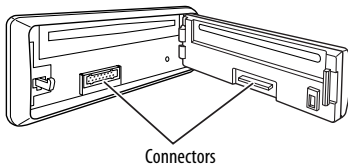

Moisture condensation

Moisture may condense on the lens inside the unit in the following cases:

- After starting the heater in the car.
 - If it becomes very humid inside the car.
- Should this occur, the unit may malfunction. In this case, eject the disc and leave the unit turned on for a few hours until the moisture has evaporated.

How to handle discs

When removing a disc from its case, press down the center holder of the case and lift the disc out, holding it by the edges.



- Always hold the disc by the edges.
Do not touch its recording surface.

When storing a disc in its case, gently insert the disc around the center holder (with the printed surface facing up).

- Make sure to store discs in cases after use.

To keep discs clean

A dirty disc may not play correctly. If a disc does become dirty, wipe it with a soft cloth in a straight line from center to edge.



- Do not use any solvents (for example, conventional record cleaner, spray, thinner, benzene, etc.) to clean discs.

Continued on the next page

To play new discs

New discs may have some rough spots around the inner and outer edges. If such a disc is used, this unit may reject the disc.

To remove these rough spots, rub the edges with a pencil or ball-point pen, etc.



Do not use the following discs:

Single CD (8 cm disc)



Warped disc



Sticker and sticker residue



Stick-on label



Unusual shape



C-thru Disc (semi-transparent disc)



Transparent or semi-transparent parts on its recording area



More about this unit

Basic operations

Turning on the power

- By pressing SRC on the unit, you can also turn on the power. If the source is ready, playback also starts.

Turning off the power

- If you turn off the power while listening to a disc, disc play will start from where it had been stopped previously next time you turn on the power.

Tuner operations

Storing stations in memory

- During SSM search...
 - All previously stored stations are erased and the stations are stored anew.

- Received stations are preset in No. 1 (lowest frequency) to No. 6 (highest frequency).
- When SSM is over, the station stored in No. 1 will be automatically tuned in.
- When storing a station manually, the previously preset station is erased when a new station is stored in the same preset number.

FM Radio Data System operations

- Network-Tracking Reception requires two types of Radio Data System signals—PI (Programme Identification) and AF (Alternative Frequency) to work correctly. Without receiving these data correctly, Network-Tracking Reception will not operate correctly.
- If a Traffic Announcement is received by TA Standby Reception, the volume level automatically changes to the preset level (TA VOL) if the current level is lower than the preset level.
- When Alternative Frequency Reception is activated (with AF selected), Network-Tracking Reception is also activated automatically. On the other hand, Network-Tracking Reception cannot be deactivated without deactivating Alternative Frequency Reception. (See page 13.)

Disc operations

Caution for DualDisc playback

- The Non-DVD side of a "DualDisc" does not comply with the "Compact Disc Digital Audio" standard. Therefore, the use of Non-DVD side of a DualDisc on this product may not be recommended.

General

- This unit has been designed to reproduce CDs/CD Texts, and CD-Rs (Recordable)/CD-RWs (Rewritable) in audio CD (CD-DA), MP3/WMA (for KD-R203) formats.
- KD-R203: MP3 and WMA "tracks" (words "file" and "track" are used interchangeably) are recorded in "folders."
- KD-R203: While fast-forwarding or reversing on an MP3 or WMA disc, you can only hear intermittent sounds.

Playing a CD-R or CD-RW

- Use only "finalized" CD-Rs or CD-RWs.

- KD-R203: This unit can only play back files of the same type as those which are detected first if a disc includes both audio CD (CD-DA) files and MP3/WMA files.
- This unit can play back multi-session discs; however, unclosed sessions will be skipped while playing.
- Some CD-Rs or CD-RWs may not be played back on this unit because of their disc characteristics, or for the following reasons:
 - Discs are dirty or scratched.
 - Moisture condensation has occurred on the lens inside the unit.
 - The pickup lens inside the unit is dirty.
 - The files on the CD-R/CD-RW are written using the “Packet Write” method.
 - There are improper recording conditions (missing data, etc.) or media conditions (stained, scratched, warped, etc.).
- CD-RWs may require a longer readout time since the reflectance of CD-RWs is lower than that of regular CDs.
- Do not use the following CD-Rs or CD-RWs:
 - Discs with stickers, labels, or protective seal stuck to the surface.
 - Discs on which labels can be directly printed by an ink jet printer.

Using these discs under high temperature or high humidity may cause malfunctions or damage to the unit.
- ISO 9660 Level 1: up to 12 characters
- ISO 9660 Level 2: up to 31 characters
- Romeo: up to 128 characters
- Joliet: up to 64 characters
- Windows long file name: up to 128 characters
- This unit can recognize a total of 512 files, 200 folders, and 8 hierarchical levels.
- This unit can play back files recorded in VBR (variable bit rate).
Files recorded in VBR have a discrepancy in the elapsed time display, and do not show the actual elapsed time. In particular, this difference becomes noticeable after performing the search function.
- This unit cannot play back the following files:
 - MP3 files encoded in MP3i and MP3 PRO format.
 - MP3 files encoded in an inappropriate format.
 - MP3 files encoded with Layer 1/2.
 - WMA files encoded in lossless, professional, and voice format.
 - WMA files which are not based upon Windows Media® Audio.
 - WMA files copy-protected with DRM.
 - Files which have data such as WAVE, ATRAC3, etc.
- The search function works but search speed is not constant.

Playing an MP3/WMA disc (for KD-R203)

- This unit can play back MP3/WMA files with the extension code <.mp3> or <.wma> (regardless of the letter case—upper/lower).
- This unit can show the names of albums, artists (performer), and Tag (Version 1.0, 1.1, 2.2, 2.3, or 2.4) for MP3 files and for WMA files.
- This unit can display only one-byte characters. No other characters can be correctly displayed.
- This unit can play back MP3/WMA files meeting the conditions below:
 - Bit rate: 8 kbps — 320 kbps
 - Sampling frequency:
 - 48 kHz, 44.1 kHz, 32 kHz (for MPEG-1)
 - 24 kHz, 22.05 kHz, 16 kHz (for MPEG-2)
 - Disc format: ISO 9660 Level 1/ Level 2, Romeo, Joliet, Windows long file name
- The maximum number of characters for file/folder names vary depending on the disc format used (includes 4 extension characters—<.mp3> or <.wma>).

Changing the source

- If you change the source, playback also stops (without ejecting the disc).
Next time you select “CD” for the playback source, disc play starts from where it has been stopped previously.

Ejecting a disc

- If the ejected disc is not removed within 15 seconds, it is automatically inserted into the loading slot again to protect it from dust.
- After ejecting a disc, “NO DISC” appears and you cannot operate some of the buttons. Insert another disc or press SRC to select another playback source.

General settings—PSM

- If you change the “AMP GAIN” setting from “HIGH PWR” to “LOW PWR” while the volume level is set higher than “VOL 30,” the unit automatically changes the volume level to “VOL 30.”

Troubleshooting

What appears to be trouble is not always serious. Check the following points before calling a service center.

	Symptoms	Remedies/Causes
General	• Sound cannot be heard from the speakers.	• Adjust the volume to the optimum level. • Check the cords and connections.
	• The unit does not work at all.	Reset the unit (see page 2).
FM/AM	• SSM automatic presetting does not work.	Store stations manually.
	• Static noise while listening to the radio.	Connect the aerial firmly.
Disc playback	• Disc cannot be played back.	Insert the disc correctly.
	• CD-R/CD-RW cannot be played back.	• Insert a finalized CD-R/CD-RW.
	• Tracks on the CD-R/CD-RW cannot be skipped.	• Finalize the CD-R/CD-RW with the component which you used for recording.
	• Disc can be neither played back nor ejected.	• Unlock the disc (see page 10). • Eject the disc forcibly (see page 2).
	• Disc sound is sometimes interrupted.	• Stop playback while driving on rough roads. • Change the disc. • Check the cords and connections.
	• "NO DISC" appears on the display. • "PLEASE" and "EJECT" appear alternately on the display.	Insert a playable disc into the loading slot.
MP3/WMA playback (for KD-R203)	• Disc cannot be played back.	• Use a disc with MP3/WMA tracks recorded in a format compliant with ISO 9660 Level 1, Level 2, Romeo, or Joliet. • Add the extension code <.mp3> or <.wma> to the file names.
	• Noise is generated.	Skip to another track or change the disc. (Do not add the extension code <.mp3> or <.wma> to non-MP3 or WMA tracks.)
	• A longer readout time is required ("READING" keeps flashing on the display).	Do not use too many hierarchical levels and folders.
	• Tracks are not played back in the order you have intended.	The playback order is determined when the files are recorded.
	• The elapsed playing time is not correct.	This sometimes occurs during playback. This is caused by how the tracks are recorded on the disc.
	• The correct characters are not displayed (e.g. album name).	This unit can only display alphabets (upper case), numbers, and a limited number of symbols.

- Microsoft and Windows Media are either registered trademarks or trademarks of Microsoft Corporation in the United States and/or other countries.

Specifications

AUDIO AMPLIFIER SECTION

Maximum Power Output:	
Front/Rear:	50 W per channel
Continuous Power Output (RMS):	
Front/Rear:	19 W per channel into 4 Ω , 40 Hz to 20 000 Hz at no more than 0.8% total harmonic distortion.
Load Impedance:	4 Ω (4 Ω to 8 Ω allowance)
Tone Control Range:	
Bass:	± 12 dB at 100 Hz
Treble:	± 12 dB at 10 kHz
Frequency Response:	40 Hz to 20 000 Hz
Signal-to-Noise Ratio:	70 dB
Line-Out Level/Impedance:	2.5 V/20 k Ω load (full scale)
Output Impedance:	1 k Ω
Other Terminal:	AUX (auxiliary) input jack

TUNER SECTION

Frequency Range:	
FM:	87.5 MHz to 108.0 MHz
AM:	MW: 522 kHz to 1 620 kHz LW: 144 kHz to 279 kHz
FM Tuner	
Usable Sensitivity:	11.3 dBf (1.0 μ V/75 Ω)
50 dB Quieting Sensitivity:	16.3 dBf (1.8 μ V/75 Ω)
Alternate Channel Selectivity (400 kHz):	65 dB
Frequency Response:	40 Hz to 15 000 Hz
Stereo Separation:	30 dB
MW Tuner	
Sensitivity/Selectivity:	20 μ V/35 dB
LW Tuner	
Sensitivity:	50 μ V

CD PLAYER SECTION

Type:	Compact disc player
Signal Detection System:	Non-contact optical pickup (semiconductor laser)
Number of Channels:	2 channels (stereo)
Frequency Response:	5 Hz to 20 000 Hz
Dynamic Range:	93 dB
Signal-to-Noise Ratio:	98 dB
Wow and Flutter:	Less than measurable limit
For KD-R203	
MP3 Decoding Format: (MPEG1/2 Audio Layer 3)	
Max. Bit Rate:	320 kbps
WMA (Windows Media [®] Audio) Decoding Format:	
Max. Bit Rate:	192 kbps

GENERAL

Power Requirement:	
Operating Voltage:	DC 14.4 V (11 V to 16 V allowance)
Grounding System:	Negative ground
Allowable Operating Temperature:	0°C to +40°C
Dimensions (W \times H \times D): (approx.)	
Installation Size:	182 mm \times 52 mm \times 160 mm
Panel Size:	188 mm \times 58 mm \times 13 mm
Mass:	1.3 kg (excluding accessories)

Design and specifications are subject to change without notice.

Having TROUBLE with operation?

Please reset your unit

Refer to page of How to reset your unit

Haben Sie PROBLEME mit dem Betrieb?

Bitte setzen Sie Ihr Gerät zurück

Siehe Seite Zurücksetzen des Geräts

Затруднения при эксплуатации?

Пожалуйста, перезагрузите Ваше устройство

Для получения информации о перезагрузке Вашего устройства обратитесь на соответствующую страницу

Αντιμετωπίζετε ΠΡΟΒΛΗΜΑΤΑ λειτουργίας;

Εκτελέστε επαναφορά της μονάδας

Ανατρέξτε στην ενότητα “Επαναφορά της μονάδας”

Dear Customer,

This apparatus is in conformance with the valid European directives and standards regarding electromagnetic compatibility and electrical safety.

European representative of Victor Company of Japan, Limited is:

JVC Technical Services Europe GmbH
Postfach 10 05 04
61145 Friedberg
Germany

Sehr geehrter Kunde, sehr geehrte Kundin, dieses Gerät stimmt mit den gültigen europäischen Richtlinien und Normen bezüglich elektromagnetischer Verträglichkeit und elektrischer Sicherheit überein.

Die europäische Vertretung für die Victor Company of Japan, Limited ist:

JVC Technical Services Europe GmbH
Postfach 10 05 04
61145 Friedberg
Deutschland

Уважаемый клиент.

Данное устройство соответствует действительным Европейским директивам и стандартам по электромагнитной совместимости и электрической безопасности.

Представительство компании Victor Company of Japan, Limited в Европе:

JVC Technical Services Europe GmbH
Postfach 10 05 04
61145 Friedberg
Германия

Αγαπητέ πελάτη, η συσκευή αυτή συμμορφώνεται με τις ισχύουσες Ευρωπαϊκές Οδηγίες και πρότυπα σχετικά με την ηλεκτρομαγνητική συμβατότητα και την ασφάλεια από ηλεκτρισμό.

Ο Ευρωπαϊκός αντιπρόσωπος της Victor Company of Japan, Limited είναι:

JVC Technical Services Europe GmbH
Postfach 10 05 04
61145 Friedberg
Γερμανία

JVC



EN, GE, RU, GR

© 2008 Victor Company of Japan, Limited

0808DTSMDTJEIN

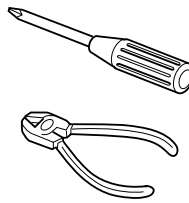

ENGLISH

This unit is designed to operate on **12 V DC, NEGATIVE ground electrical systems**. If your vehicle does not have this system, a voltage inverter is required, which can be purchased at JVC IN-CAR ENTERTAINMENT dealers.

DEUTSCH

Dieses Gerät ist für einen Betrieb in **elektrischen Anlagen mit 12 V Gleichstrom und (-) Erdung ausgelegt**. Verfügt Ihr Fahrzeug nicht über diese Anlage, ist ein **Spannungsinverter** erforderlich, der bei JVC Autoradiohändler erworben werden kann.

РУССКИЙ

Это устройство разработано для эксплуатации на **12 В постоянного напряжения с минусом на массе**. Если Ваш автомобиль не имеет этой системы, требуется инвертор напряжения, который может быть приобретен у дилера автомобильного специалиста JVC.

ΕΛΛΗΝΙΚΑ

Η συσκευή αυτή είναι σχεδιασμένη να λειτουργεί σε ηλεκτρικά συστήματα οχημάτων στα **12 V DC, με ΑΡΝΗΤΙΚΗ γείωση**. Εάν το όχημά σας δεν ανήκει στην κατηγορία αυτή, θα χρειαστείτε ένα μετατροπέα τάσης, τον οποίο μπορείτε να προμηθευτείτε από τους αντιπροσώπους συστημάτων ψυχαγωγίας οχημάτων της JVC.

WARNINGS

To prevent short circuits, we recommend that you disconnect the battery's negative terminal and make all electrical connections before installing the unit.

- **Be sure to ground this unit to the car's chassis again after installation.**

Notes:

- Replace the fuse with one of the specified rating. If the fuse blows frequently, consult your JVC IN-CAR ENTERTAINMENT dealer.
- It is recommended to connect to the speakers with maximum power of more than 50 W (both at the rear and at the front, with an impedance of **4 Ω to 8 Ω**). If the maximum power is less than 50 W, change "AMP GAIN" setting to prevent the speakers from being damaged (see page 14 of the INSTRUCTIONS).
- To prevent short-circuit, cover the terminals of the UNUSED leads with insulating tape.
- The heat sink becomes very hot after use. Be careful not to touch it when removing this unit.

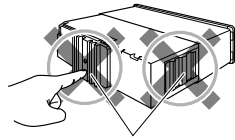

Heat sink
Abstrahlblech
Радиатор
Ψύκτρα

WARNUNGEN

Zur Vermeidung von Kurzschlüssen empfehlen wir, daß Sie den negativen Batterieanschluß abtrennen und alle elektrischen Anschlüsse herstellen, bevor das Gerät eingebaut wird.

- **Sicherstellen, daß das Gerät nach dem Einbau a Chassis des Fahrzeugs geerdet wird.**

Hinweise:

- Die Sicherung mit einer der entsprechenden Nennleistung ersetzen. Brennt die Sicherung häufig durch, wenden Sie sich an ihren JVC Autoradiohändler.
- Es wird empfohlen, Lautsprecher mit einer Maximalleistung von mehr als 50 W anzuschließen (sowohl hinten als auch vorne, mit einer Impedanz von **4 Ω bis 8 Ω**). Wenn die Maximalleistung weniger als 50 W beträgt, stellen Sie „AMP GAIN“ anders ein, um Schäden an den Lautsprechern zu vermeiden (siehe Seite 14 der BEDIENUNGSANLEITUNG).
- Zur Vermeidung eines Kurzschlusses die Anschlußklemmen der NICHT VERWENDETEN Leitungen mit Isolierklebeband umwickeln.
- Das Abstrahlblech wird nach dem Gebrauch sehr heiß. Beim Ausbau des Geräts darauf achten, das Abstrahlblech nicht zu berühren.

ΠΡΕΔΥΠΡΕΪΔΕΝΙΑ

Для предотвращения коротких замыканий мы рекомендуем Вам отсоединить отрицательный разъем аккумулятора и осуществить все подключения перед установкой устройства.

- **После установки обязательно заземлите данное устройство на шасси автомобиля.**

Примечания:

- Заменяйте предохранитель другим предохранителем указанного класса. Если предохранитель сгорает слишком часто, обратитесь к дилеру автомобильного специалиста JVC.
- Рекомендуется подключать динамики с максимальной мощностью более 50 Вт (к задней и передней панели устройства, с полным сопротивлением от **4 Ω до 8 Ω**). Если максимальная мощность динамиков менее 50 Вт, перейдите в режим "AMP GAIN", чтобы предотвратить их повреждение (см. ИНСТРУКЦИИ ПО ЭКСПЛУАТАЦИИ на стр. 14).
- Для предотвращения короткого замыкания заклейте НЕИСПОЛЬЗУЕМЫЕ концы изолирующей лентой.
- Радиатор во время использования сильно нагревается. Старайтесь его не трогать во время удаления устройства.

ΠΡΟΦΥΛΑΞΕΙΣ

Για την αποτροπή τυχόν βραχυκυκλωμάτων, συνιστούμε να αποσυνδέετε τον αρνητικό πόλο της μπαταρίας και να κάνετε όλες τις ηλεκτρικές συνδέσεις πριν από την εγκατάσταση της συσκευής.

- **Βεβαιωθείτε ότι θα γειώσετε τη συσκευή αυτή στο αμάξωμα του οχήματος ξανά μετά την εγκατάσταση.**

Σημειώσεις:

- Εάν καεί η ασφάλεια, αντικαταστήστε την με καινούργια των ίδιων ονομαστικών χαρακτηριστικών. Εάν η ασφάλεια καίγεται συχνά, συμβουλευθείτε τον αντιπρόσωπο συστημάτων ψυχαγωγίας οχημάτων της JVC.
- Συνιστάται να συνδέετε ηχεία μέγιστης ισχύος πάνω από 50 W (τόσο πίσω όσο και μπροστά, με σύνθετη αντίσταση **4 Ω έως 8 Ω**). Εάν η μέγιστη ισχύς των ηχείων είναι μικρότερη από 50 W, αλλάξτε τη ρύθμιση "AMP GAIN" (Απολαβή ενισχυτή) για να αποτρέψετε ενδεχόμενη καταστροφή τους (βλ. σελίδα 14 στις ΟΔΗΓΙΕΣ).
- Για να αποτρέψετε τυχόν βραχυκυκλώματα, καλύψτε τους ακροδέκτες των καλωδίων ΠΟΥ ΔΕ ΧΡΗΣΙΜΟΠΟΙΕΙΤΕ με μονωτική ταινία.
- Η ψύκτρα ζεσταίνεται πολύ κατά τη χρήση. Προσέχετε να μην την αγγίξετε καθώς αφαιρείτε τη συσκευή.

PRECAUTIONS on power supply and speaker connections:

- **DO NOT connect the speaker leads of the power cord to the car battery; otherwise, the unit will be seriously damaged.**
- BEFORE connecting the speaker leads of the power cord to the speakers, check the speaker wiring in your car.

VORSICHTSMASSEGELN beim Anschließen der Stromversorgung und Lautsprecher:

- Die Lautsprecherleitungen des Netzkabels **NICHT an der Autobatterie anschließen, da sonst das Gerät schwer beschädigt wird.**
- VOR dem Anschließen der Lautsprecherleitungen des Spannungsversorgungskabels an die Lautsprecher, die Lautsprecherverdrahtung in Ihrem Auto überprüfen.

ΠΡΕΔΟΣΤΕΡΕΪΔΕΝΙΑ πο ΠΙΤΑΝΙΟ ΙΙ ποΔΚΛΗΤΗΙΟ ΓΡΟΜΚΟΓΩΡΙΤΕΛΕΙ:

- **НЕ подключайте провода громкоговорителей к аккумулятору автомобиля, иначе устройство будет повреждено.**
- ПЕРЕД подключением проводов громкоговорителей к кабелю питания громкоговорителя проверьте схему соединений громкоговорителей в Вашем автомобиле.

ΠΡΟΦΥΛΑΞΕΙΣ κατά τις συνδέσεις τροφοδοσίας ρεύματος και ηχείων:

- **ΜΗ συνδέετε τα καλώδια ηχείων της συσκευής με την μπαταρία του οχήματος, διότι ενδέχεται να προκληθεί σοβαρή ζημιά στη συσκευή.**
- ΠΡΟΤΟΥ συνδέσετε τα καλώδια ηχείων της συσκευής με τα ηχεία, ελέγξτε την καλωδίωση των ηχείων του οχήματος.

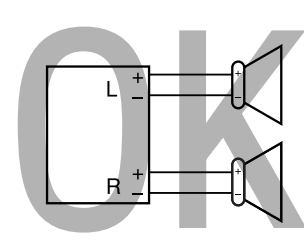
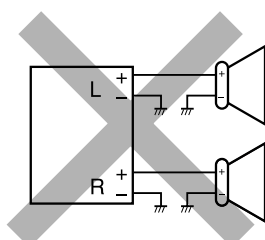
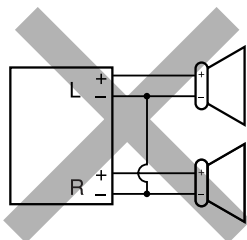

Parts list for installation and connection

The following parts are provided for this unit. If any item is missing, consult your JVC IN-CAR ENTERTAINMENT dealer immediately.

Teileliste für den Einbau und Anschluß

Die folgenden Teile werden zusammen mit diesem Gerät geliefert. Falls ein Artikel fehlt, wenden Sie sich sofort an Ihren JVC-Autoradiohändler.

Список деталей для установки и подключения

Следующие детали поставлены в комплекте с устройством. При отсутствии какого-либо элемента немедленно свяжитесь с дилером автомобильного специалиста JVC.

Κατάλογος εξαρτημάτων για την εγκατάσταση και τις συνδέσεις

Η συσκευή αυτή συνοδεύεται από τα εξαρτήματα που αναφέρονται κατωτέρω. Αν λείπει κάποιο στοιχείο, συμβουλευτείτε αμέσως τον αντιπρόσωπο συστημάτων ψυχαγωγίας οχημάτων της JVC.

Ⓐ Control panel
Schalttafel
Πанель управления
Πρόσοψη

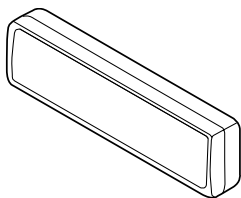

Ⓑ Sleeve
Halterung
Муфта
Βάση

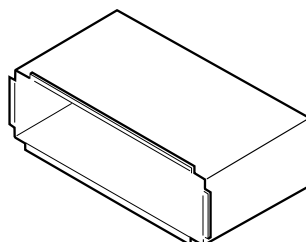

Ⓒ Trim plate
Frontrahmen
Декоративную панель
Διακοσμητικό πλαίσιο

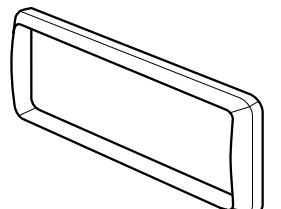

Ⓓ Power cord
Stromkabel
Καбель питания
Δέσμη καλωδίων ρεύματος

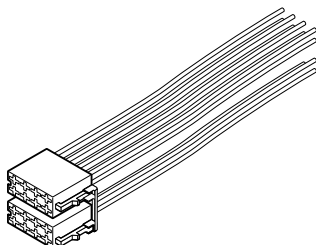

Ⓔ Washer (ø5)
Unterlegscheibe (ø5)
Шайба (№5)
Ροδέλα (ø5)



Ⓕ Lock nut (M5)
Sicherungsmutter (M5)
Φικсирующая гайка (M5)
Ασφαλιστικό παξιμάδι (M5)



Ⓖ Mounting bolt (M4 × 5 mm; M5 × 12,5 mm)
Befestigungsschraube (M4 × 5 mm; M5 × 12,5 mm)
Крепежный болт (M4 × 5 mm; M5 × 12,5 mm)
Βίδα στερέωσης (M4 × 5 mm; M5 × 12,5 mm)

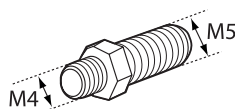

Ⓖ Rubber cushion
Gummipuffer
Резиновый чехол
Ελαστικό παρέμβυσμα



Ⓖ Handles
Griffe
Рычаги
Κλειδιά

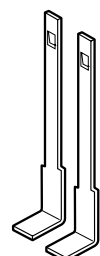

INSTALLATION (IN-DASH MOUNTING)

The following illustration shows a typical installation. If you have any questions or require information regarding installation kits, consult your JVC IN-CAR ENTERTAINMENT dealer or a company supplying kits.

- If you are not sure how to install this unit correctly, have it installed by a qualified technician.

EINBAU (IM ARMATURENBRETT)

Die folgende Abbildung zeigt einen typischen Einbau. Bei irgendwelchen Fragen oder wenn Sie Informationen hinsichtlich des Einbausatzes brauchen, wenden Sie sich an ihren JVC Autoradiohändler oder ein Unternehmen das diese Einbausätze vertreibt.

- Sind Sie sich über den richtigen Einbau des Geräts nicht sicher, lassen Sie es von einem qualifizierten Techniker einbauen.

УСТАНОВКА (УСТАНОВКА В ПРИБОРНУЮ ПАНЕЛЬ)

На следующих иллюстрациях показана типовая установка. Если у Вас есть какие-либо вопросы, касающиеся установки, обратитесь к Вашему дилеру автомобильного специалиста JVC или в компанию, поставляющую соответствующие принадлежности.

- Если Вы не знаете точно, как следует устанавливать это устройство, обратитесь к квалифицированному специалисту.

ΕΓΚΑΤΑΣΤΑΣΗ (ΤΟΠΟΘΕΤΗΣΗ ΣΤΟ ΤΑΜΠΛΩ)

Η εικόνα που ακολουθεί απεικονίζει μια τυπική εγκατάσταση. Για οποιαδήποτε απορία σας ή για περισσότερες πληροφορίες σχετικά με kit εγκατάστασης, απευθυνθείτε στον αντιπρόσωπο συστημάτων ψυχαγωγίας οχημάτων της JVC ή σε εταιρείες που παρέχουν τέτοια kit.

- Εάν έχετε αμφιβολίες σχετικά με τη σωστή εγκατάσταση της συσκευής αυτής, αναθέστε την εγκατάστασή της σε κατάλληλα εκπαιδευμένο τεχνικό.

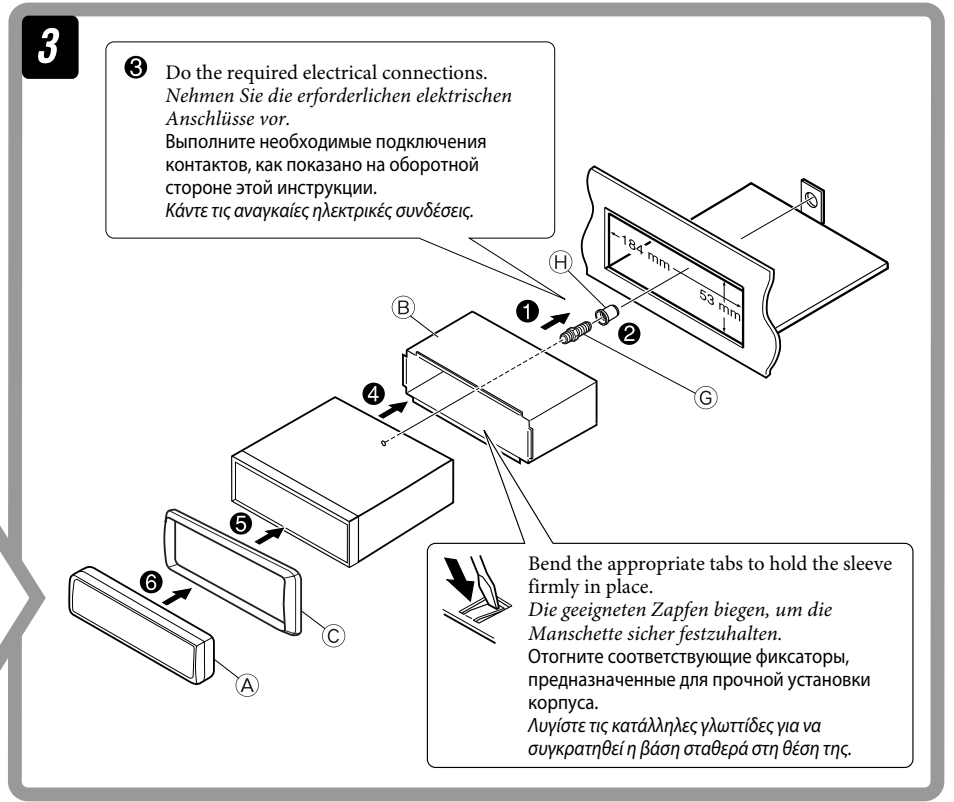
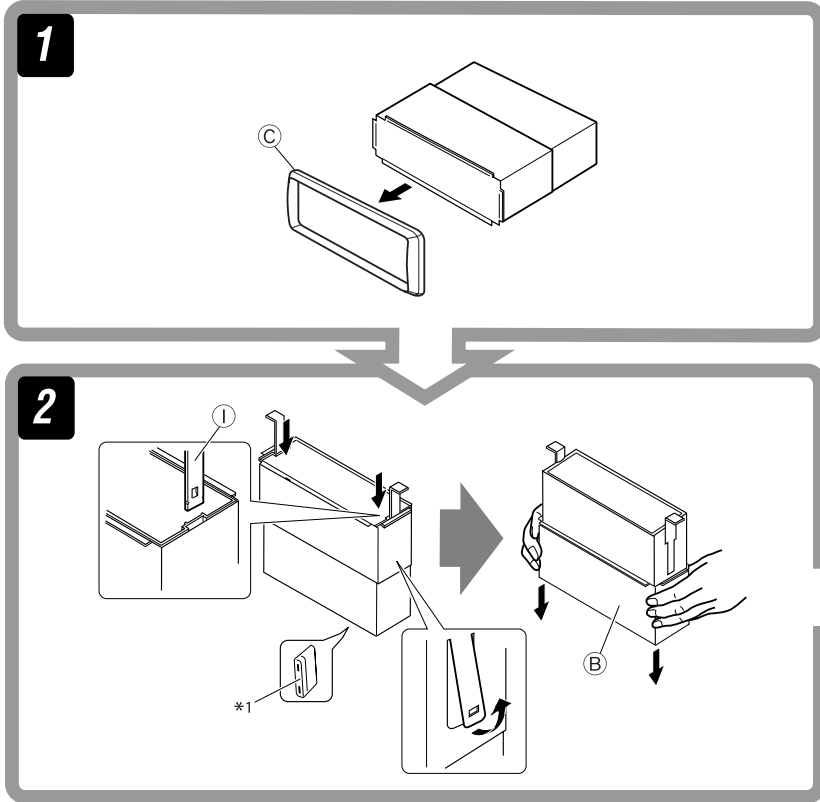

Removing the unit

Before removing the unit, release the rear section.

Ausbau des Geräts

Vor dem Ausbau des Geräts den hinteren Teil freigeben.

Удаление устройства

Перед удалением устройства освободите заднюю часть.

Αφαίρεση της συσκευής

Προτού αφαιρέσετε τη συσκευή, απασφαλίστε το πίσω μέρος.

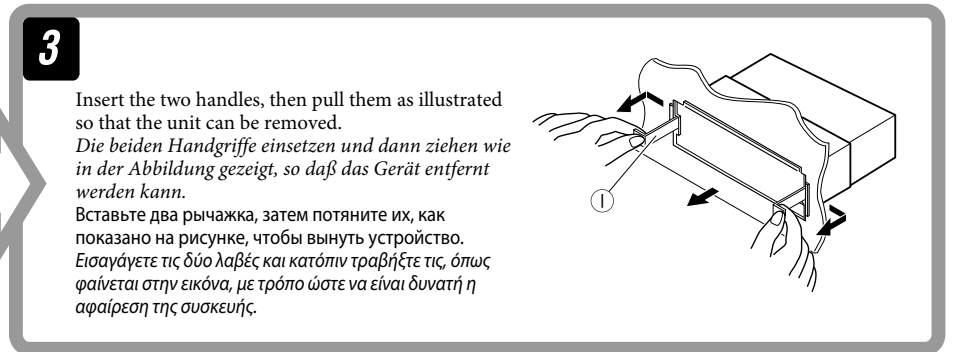
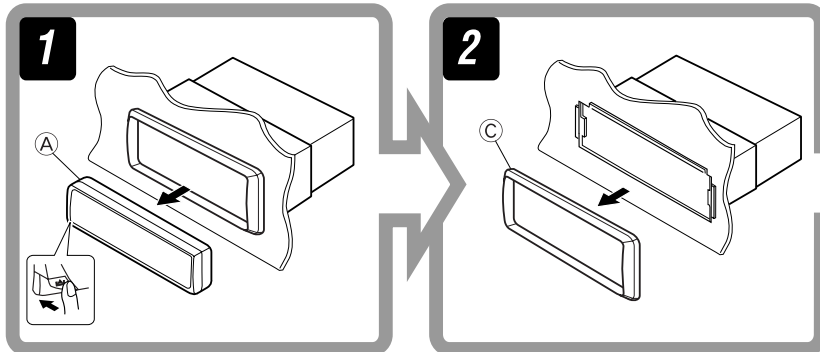

When using the optional stay / Beim Verwenden der Anker-Option / При использовании дополнительной стойки / Όταν χρησιμοποιείτε το προαιρετικό στήριγμα

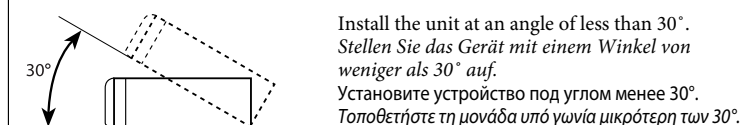
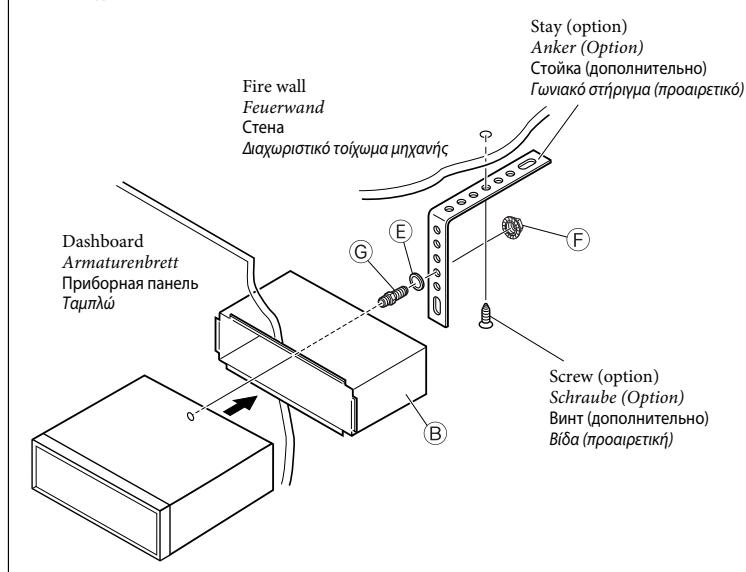

When installing the unit without using the sleeve / Beim Einbau des Geräts ohne Halterung / При установке устройства без использования муфты / Όταν τοποθετείτε τη συσκευή χωρίς χρήση της βάσης

In a Toyota car for example, first remove the car radio and install the unit in its place. *Zum Beispiel in einem Toyota zuerst das Autoradio ausbauen und dann das Gerät an seinem Platz einbauen.* В автомобиле Тойота, например, сначала извлеките автомобильный радиоприемник и установите устройство на место. *Στα οχήματα της Toyota, για παράδειγμα, πρώτα πρέπει να αφαιρέσετε το ραδιόφωνο και κατόπιν να τοποθετήσετε τη συσκευή στη θέση του.*

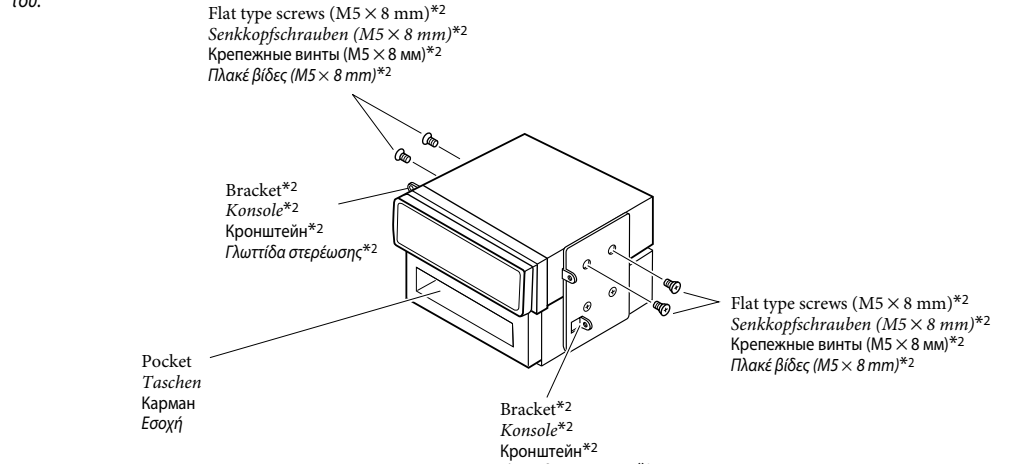

- Note** : When installing the unit on the mounting bracket, make sure to use the 8 mm-long screws. If longer screws are used, they could damage the unit.
- Hinweis** : Beim Anbringen des Gerät an der Konsole sicherstellen, daß 8 mm lange Schrauben verwendet werden. Werden längere Schrauben verwendet, können sie das Gerät beschädigen.
- Примечание** : При установке устройства на крепежный кронштейн, используйте только винты длиной 8 мм. При использовании более длинных винтов можно повредить устройство.
- Σημείωση** : Όταν τοποθετείτε τη συσκευή στο στήριγμα στερέωσης, βεβαιωθείτε ότι θα χρησιμοποιήσετε τις βίδες μήκους 8 mm. Εάν χρησιμοποιήσετε μακρότερες βίδες, ενδέχεται να προκαλέσετε ζημιά στη συσκευή.

*1 When you stand the unit, be careful not to damage the fuse on the rear.
*2 Not supplied for this unit.

*1 Beim Aufstellen des Geräts darauf achten, daß die Sicherung auf der Rückseite nicht beschädigt wird.
*2 Wird nicht mit Gerät mitgeliefert.

*1 Устанавливайте устройство таким образом, чтобы не повредить предохранитель, расположенный сзади.
*2 Не входит в комплект поставки.

*1 Όταν τοποθετείτε τη συσκευή σε όρθια θέση, προσέχετε να μην προκαλέσετε ζημιά στην ασφάλεια που βρίσκεται στο πίσω μέρος της συσκευής.
*2 Δε συμπεριλαμβάνονται στη συσκευασία της συσκευής αυτής.

ELECTRICAL CONNECTIONS

ELEKTRISCHE ANSCHLÜSSE

ЭЛЕКТРИЧЕСКИЕ ПОДКЛЮЧЕНИЯ

ΗΛΕΚΤΡΙΚΕΣ ΣΥΝΔΕΣΕΙΣ

A Typical Connections / Typische Anschlüsse / Типичные подключения / Τυπικές συνδέσεις

Before connecting: Check the wiring in the vehicle carefully. Incorrect connection may cause serious damage to this unit.
The leads of the power cord and those of the connector from the car body may be different in color.

- 1 Connect the colored leads of the power cord in the order specified in the illustration below.
- 2 Connect the aerial cord.
- 3 Finally connect the wiring harness to the unit.

Note: If your vehicle does not have any accessory terminal, move the fuse from the fuse position 1 (initial position) to fuse position 2, and connect the red lead (A7) to the positive (+) battery terminal.

- The yellow lead (A4) is not used in this case.

Vor dem Anschließen: Die Verdrahtung im Fahrzeug sorgfältig überprüfen. Falsche Anschlüsse können ernsthafte Schäden am Gerät hervorrufen.
Die Leiter des Stromkabels und die Leiter des Anschlusses im Fahrzeug können sich farblich unterscheiden.

- 1 Die farbigen Adern des Stromkabels in der Reihenfolge anschließen, wie in der Abbildung unten gezeigt.
- 2 Das Antennenkabel anschließen.
- 3 Die Kabelbäume am Gerät anschließen.

Hinweis: Verfügt Ihr Fahrzeug nicht über eine Zubehöranschlussklemme, die Sicherung von der 1. Sicherungsposition (Erstposition) in die 2. Sicherungsposition versetzen, die rote Leitung (A7) an der (+) Batterieanschlussklemme anschließen.

- Die gelbe Leitung (A4) wird in diesem Fall nicht verwendet.

Перед началом подключений: Тщательно проверьте проводку в автомобиле. Неправильное подключение может привести к серьезному повреждению устройства.
Жилы силового кабеля и жилы соединителя от кузова автомобиля могут быть разного цвета.

- 1 Подсоедините цветные провода шнура питания в указанном ниже порядке.
- 2 Подключите кабель антенны.
- 3 В последнюю очередь подключите электропроводку к устройству.

Примечание: Если в Вашем автомобиле никакого вспомогательного разъема не имеется, переставьте предохранитель из положения 1 предохранителя (первоначальное положение) в положение 2 предохранителя и подключите красный провод (A7) к положительному (+) полюсу аккумулятора.
• Желтый провод (A4) в этом случае не используется.

Πριν από τη σύνδεση: Ελέγξτε προσεκτικά την καλωδίωση του οχήματος. Η τυχόν εσφαλμένη σύνδεση είναι δυνατό να προκαλέσει σοβαρή ζημιά στη συσκευή.
Τα καλώδια της δέσμης καλωδίων ρεύματος της συσκευής ενδέχεται να μην έχουν το ίδιο χρώμα με τα καλώδια του συνδέσμου του οχήματος.

- 1 Συνδέστε τα χρωματιστά καλώδια της δέσμης καλωδίων ρεύματος, με τη σειρά που καθορίζεται στην εικόνα ανωτέρω.
- 2 Συνδέστε το ομοαξονικό καλώδιο της κεραίας.
- 3 Τέλος, συνδέστε το βύσμα της δέσμης καλωδίων ρεύματος στη συσκευή.

Σημείωση: Εάν το όχημά σας δε διαθέτει ακροδέκτη τροφοδοσίας ρεύματος μέσω του διακόπτη της μηχανής, μετακινήστε την ασφάλεια από τη θέση 1 (αρχική θέση) στη θέση 2 και κατόπιν συνδέστε το κόκκινο καλώδιο (A7) στο θετικό (+) πόλο της μπαταρίας.
• Στην περίπτωση αυτή, το κίτρινο καλώδιο (A4) δε χρησιμοποιείται.

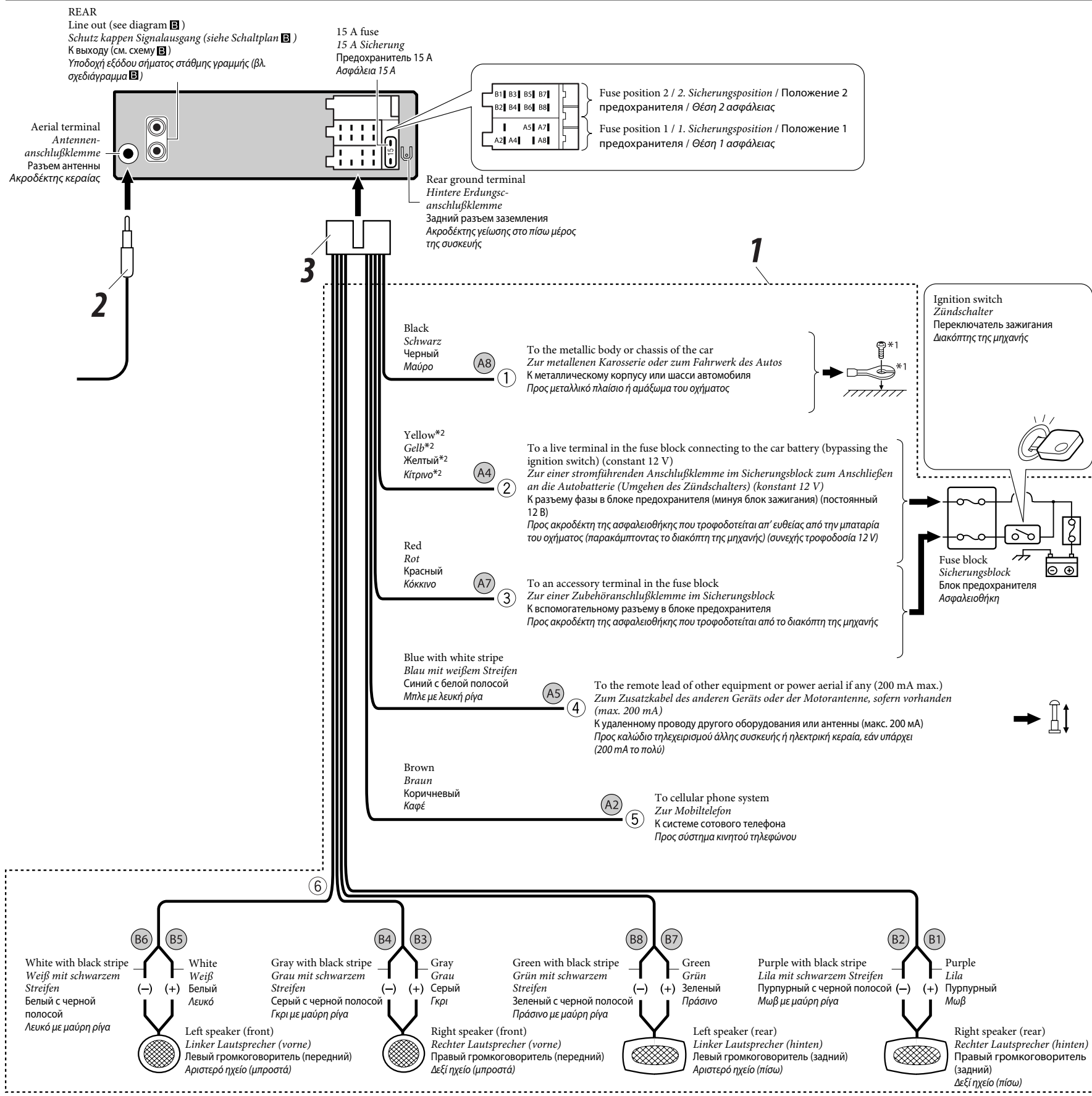

*1 Not supplied for this unit.
*2 Before checking the operation of this unit prior to installation, this lead must be connected; otherwise, the power cannot be turned on.

*1 Wird nicht mit Gerät mitgeliefert.
*2 Vor der Überprüfung der Funktionsfähigkeit des Geräts vor dem Einbau, muß diese Leitung angeschlossen werden, da sonst die Stromversorgung nicht eingeschaltet werden kann.

*1 Не входит в комплект поставки.
*2 Перед проверкой работы устройства подключите этот провод, иначе питание не включится.

*1 Δε συμπεριλαμβάνονται στη συσκευασία της συσκευής αυτής.
*2 Προτού ελέγξετε τη λειτουργία της συσκευής, πριν από την εγκατάστασή της, θα πρέπει να συνδέσετε το καλώδιο αυτό, διαφορετικά η συσκευή δε θα τεθεί σε λειτουργία.

B Connecting the external amplifier / Anschließen des externen Verstärkers / Подключение внешнего усилителя / Σύνδεση του εξωτερικού ενισχυτή

You can connect an amplifier to upgrade your car stereo system.

- Connect the remote lead (blue with white stripe) to the remote lead of the other equipment so that it can be controlled through this unit.
- **Disconnect the speakers from this unit, connect them to the amplifier. Leave the speaker leads of this unit unused.**

Sie können einen Verstärker anschließen, um Ihre Autostereoanlage zu erweitern.

- Schließen Sie das Fernbedienungskabel (blau mit weißem Streifen) an das Fernbedienungskabel des anderen Geräts an, so daß es über dieses Gerät gesteuert werden kann.
- **Die Lautsprecher von diesem Gerät abtrennen und am Verstärker anschließen. Die Lautsprecherleitungen dieses Geräts unbenutzt lassen.**

Можно подключить усилитель для обновления автомобильной стереосистемы.

- Подсоедините провод внешнего устройства (синий с белой полосой) к проводу внешнего устройства другого оборудования так, чтобы им можно было управлять с этого устройства.
- **Отсоедините громкоговорители от данного устройства, подключите их к усилителю. Оставьте провода громкоговорителей данного устройства неиспользованными.**

Μπορείτε να συνδέσετε έναν ενισχυτή για να αναβαθμίσετε το στερεοφωνικό σύστημα του αυτοκινήτου σας.

- Συνδέστε το καλώδιο τηλεχειρισμού (μπλε με λευκή ρίγα) με το καλώδιο τηλεχειρισμού της άλλης συσκευής, για να μπορείτε να ελέγχετε τη δεύτερη μέσω της πρώτης.
- **Αποσυνδέστε τα ηχεία από τη συσκευή αυτή και συνδέστε τα με τον ενισχυτή. Αφήστε τα καλώδια ηχείων της συσκευής αυτής ασύνδετα.**

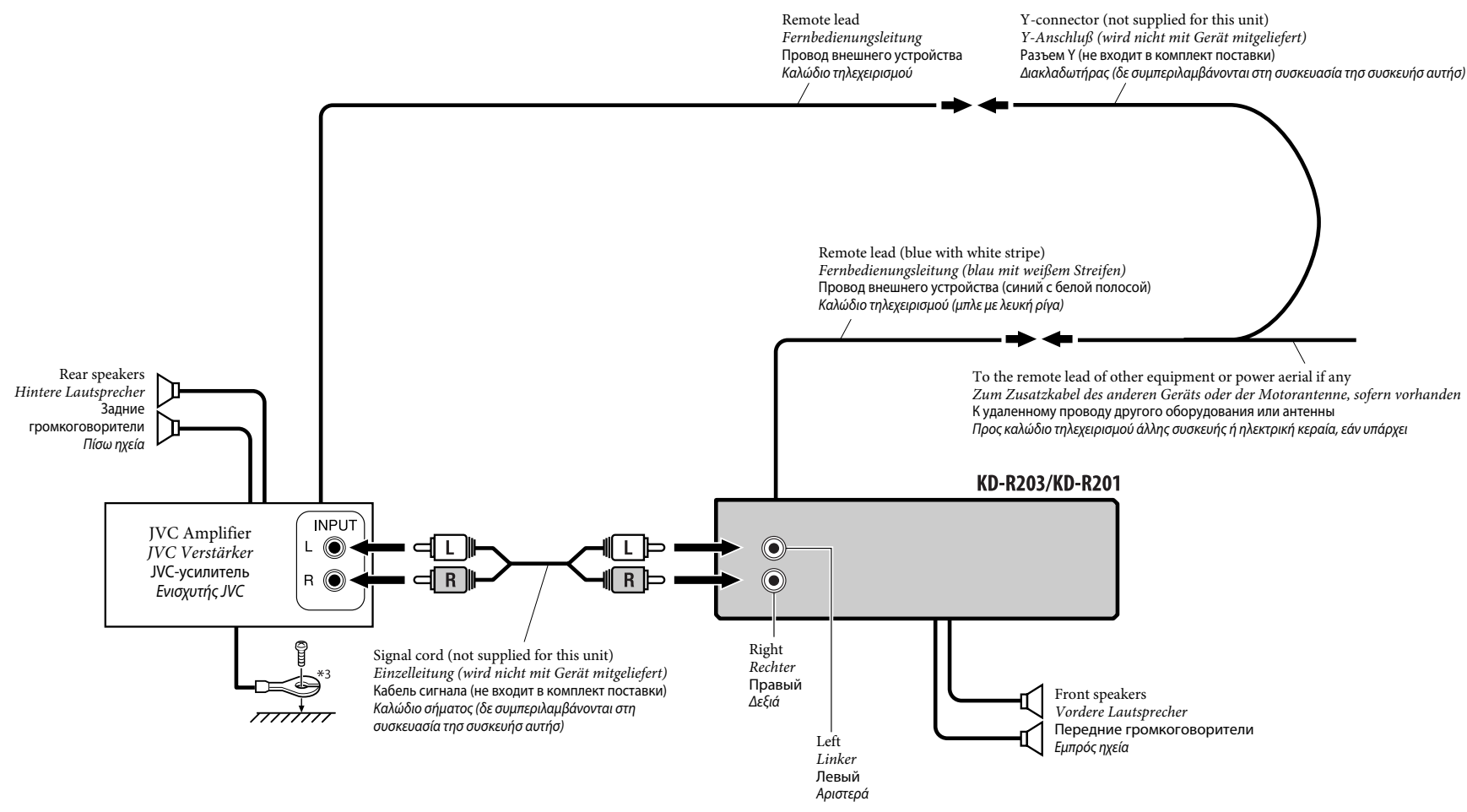

*3 Firmly attach the ground wire to the metallic body or to the chassis of the car—to the place not coated with paint (if coated with paint, remove the paint before attaching the wire). Failure to do so may cause damage to the unit.

*3 Verbinden Sie den Erdungsleiter mit der Karosserie oder dem Rahmen des Fahrzeugs. Die Kontaktstelle darf nicht lackiert sein (sollte die Kontaktstelle lackiert sein, entfernen Sie den Lack der Kontaktstelle, bevor Sie den Leiter befestigen). Wenn der Erdungsleiter nicht ordnungsgemäß angeschlossen wird, kann dieses Gerät beschädigt werden.

*3 Плотно прикрепите заземляющий провод к металлическому кузову или шасси автомобиля—в месте, не покрытом краской (если оно покрыто краской, удалите краску перед тем, как прикреплять провод). Невыполнение этого требования может привести к повреждению данного устройства.

*3 Στερεώστε γερά το καλώδιο γείωσης στο μεταλλικό πλαίσιο ή το αμάξωμα του οχήματος σε σημείο που δεν είναι βαμμένο (σε αντίθετη περίπτωση, ξύστε τη βαφή προτού συνδέσετε το καλώδιο). Αν δεν το κάνετε αυτό, είναι δυνατό να προκληθεί ζημιά στη συσκευή.

TROUBLESHOOTING

- **The fuse blows.**
 - * Are the red and black leads connected correctly?
- **Power cannot be turned on.**
 - * Is the yellow lead connected?
- **No sound from the speakers.**
 - * Is the speaker output lead short-circuited?
- **Sound is distorted.**
 - * Is the speaker output lead grounded?
 - * Are the “-” terminals of L and R speakers grounded in common?
- **Noise interfere with sounds.**
 - * Is the rear ground terminal connected to the car’s chassis using shorter and thicker cords?
- **This unit becomes hot.**
 - * Is the speaker output lead grounded?
 - * Are the “-” terminals of L and R speakers grounded in common?
- **This unit does not work at all.**
 - * Have you reset your unit?

FEHLERSUCHE

- **Die Sicherung brennt durch.**
 - * Sind die roten und schwarzen Leitungen richtig angeschlossen?
- **Stromversorgung kann nicht eingeschaltet werden.**
 - * Ist die gelbe Leitung angeschlossen?
- **Kein Ton aus den Lautsprechern.**
 - * Ist die Lautsprecherausgangsleitung kurzgeschlossen?
- **Ton verzerrt.**
 - * Ist die Lautsprecherausgangsleitung geerdet?
 - * Sind die „-“ Anschlußklemmen der linken und rechten Lautsprecher zusammen geerdet?
- **Störgeräusche im Klang.**
 - * Ist die hintere Erdungsklemme mit kürzeren und dickeren Kabeln an das Fahrzeugchassis angeschlossen?
- **Gerät wird heiß.**
 - * Ist die Lautsprecherausgangsleitung geerdet?
 - * Sind die „-“ Anschlußklemmen der linken und rechten Lautsprecher zusammen geerdet?
- **Dieser Receiver funktioniert überhaupt nicht.**
 - * Haben Sie einen Reset am Receiver vorgenommen?

ВЫЯВЛЕНИЕ НЕИСПРАВНОСТЕЙ

- **Сработал предохранитель.**
 - * Правильно ли подключены черный и красный провода?
- **Питание не включается.**
 - * Подключен ли желтый провод?
- **Звук не выводится через громкоговорители.**
 - * Нет ли короткого замыкания на кабеле выхода громкоговорителей?
- **Звук искажен.**
 - * Заземлен ли провод выхода громкоговорителей?
 - * Заземлены ли разъемы “-” правого (R) и левого (L) громкоговорителей?
- **Шум мешает звучанию.**
 - * Соединен ли находящийся сзади зажим заземления с шасси автомобиля с помощью более короткого и тонкого шнуров?
- **Устройство нагревается.**
 - * Заземлен ли провод выхода громкоговорителей?
 - * Заземлены ли разъемы “-” правого (R) и левого (L) громкоговорителей?
- **Приемник не работает.**
 - * Выполнена ли перенастройка приемника?

ΑΝΤΙΜΕΤΩΠΙΣΗ ΠΡΟΒΛΗΜΑΤΩΝ

- **Η ασφάλεια καίγεται.**
 - * Είναι το κόκκινο και το μαύρο καλώδιο σωστά συνδεδεμένα;
- **Η συσκευή δεν τίθεται σε λειτουργία.**
 - * Είναι το κίτρινο καλώδιο συνδεδεμένο;
- **Δεν παράγεται ήχος στα ηχεία.**
 - * Μήπως το καλώδιο εξόδου προς τα ηχεία είναι βραχυκυκλωμένο;
- **Ο ήχος παράγεται με παραμόρφωση.**
 - * Μήπως το καλώδιο εξόδου προς τα ηχεία είναι γειωμένο;
 - * Μήπως οι ακροδέκτες “-” των αριστερών (L) και των δεξιών (R) ηχείων είναι γειωμένοι σε κοινό σημείο;
- **Ο θόρυβος προκαλεί παρεμβολές στους παραγόμενους ήχους.**
 - * Είναι ο πίσω ακροδέκτης γείωσης συνδεδεμένος με το αμάξωμα του αυτοκινήτου με κοντότερο και παχύτερο καλώδιο;
- **Η συσκευή ζεσταίνεται πολύ.**
 - * Μήπως το καλώδιο εξόδου προς τα ηχεία είναι γειωμένο;
 - * Μήπως οι ακροδέκτες “-” των αριστερών (L) και των δεξιών (R) ηχείων είναι γειωμένοι σε κοινό σημείο;
- **Ο δέκτης αυτός δεν λειτουργεί καθόλου.**
 - * Έχετε επαναφέρει το δέκτη;

JVC KD-R207

CD RECEIVER: INSTRUCTIONS/INSTALLATION



MP3
WMA

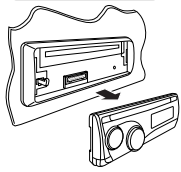
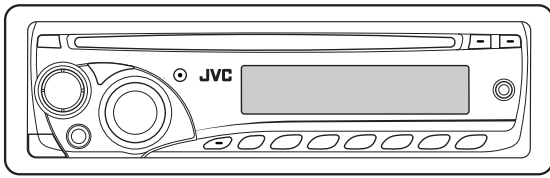

Radio Data System

GET0591-001A [EE]

0808DTSMDTJEIN
EN

© 2008 Victor Company of Japan, Limited

ENGLISH

IMPORTANT FOR LASER PRODUCTS

- CLASS 1 LASER PRODUCT
- CAUTION:** Do not open the top cover. There are no user serviceable parts inside the unit; leave all servicing to qualified service personnel.
- CAUTION:** Visible and/or invisible class 1M laser radiation when open. Do not view directly with optical instruments.
- REPRODUCTION OF LABEL: CAUTION LABEL, PLACED OUTSIDE THE UNIT.

CAUTION VISIBLE AND/OR INVISIBLE CLASS 1M LASER RADIATION WHEN OPEN. DO NOT VIEW DIRECTLY WITH OPTICAL INSTRUMENTS. IEC60825-1:2001 (ENQ)	ATTENTION RAYONNEMENT LASER VISIBLE ET/OU INVISIBLE DE CLASSE 1M UNE FOS OUVERT. NE PAS REGARDER DIRECTEMENT AVEC DES INSTRUMENTS OPTIQUES. (FRN)	AVISO RADIACION LASER DE CLASE 1M VISIBLE Y/O INVISIBLE CUANDO ESTA ABIERTO. NO MIRAR DIRECTAMENTE CON INSTRUMENTAL OPTICO. (ESP)	VARNING SYNLIG OCH/ELLER OSYNLIG LASERSTRÅLNING, KLASS 1M, NÅR DENNA LÄSARE ÄR ÖPPNAD. BETRÄKTA EJ STRÅLEN MED OPTISKA INSTRUMENT. (SWE)	注意 この製品はレーザー光線 及び/または不可視の クラス1M レーザー放射が 発生する。 光学機器で直接 見ないでください。 (JPN)	CAUTION VISIBLE AND/OR INVISIBLE CLASS II LASER RADIATION WHEN OPEN. DO NOT STARE INTO BEAM. FDA 21 CFR (ENQ)
--	--	--	---	--	--



For safety...

- Do not raise the volume level too much, as this will block outside sounds, making driving dangerous.
- Stop the car before performing any complicated operations.

Temperature inside the car...

If you have parked the car for a long time in hot or cold weather, wait until the temperature in the car becomes normal before operating the unit.

Warning

If you need to operate the unit while driving, be sure to look around carefully or you may be involved in a traffic accident.

Caution on volume setting

Discs produce very little noise compared with other sources. Lower the volume before playing a disc to avoid damaging the speakers by the sudden increase of the output level.

PREPARATIONS

Detaching the control panel

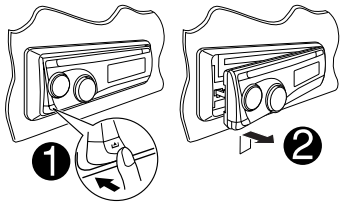

How to reset your unit

Reset the unit after installation is complete.

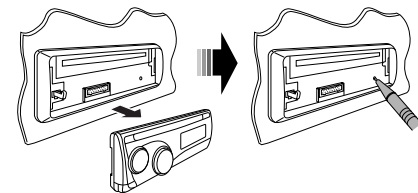

- Your preset adjustments will also be erased.

Attaching the control panel

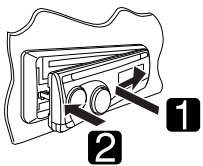

How to forcibly eject a disc



- Be careful not to drop the disc when it ejects.
- If this does not work, reset your unit.

Basic settings

- Enter PSM menu.**
SEL [Hold]
- Select an item.**
1 **Canceling the display demonstrations**
Select "DEMO," then "DEMO OFF."
2 **Setting the clock**
Select "CLOCK H" (hour), then adjust the hour.
Select "CLOCK M" (minute), then adjust the minute.
Select "24H/12H," then "24H" (hour) or "12H" (hour).
Adjust.
[Turn]
- Finish**
SEL

Available characters on the display

Available characters	Display indications
А Б В Г Д Е Ж З И Й К Л М Н О П Р С Т У Ф Х Ц Ч Ш Щ	
А Б В Г Д Е Ж З И Й К Л М Н О П Р С Т У Ф Х Ц Ч Ш Щ	
Ъ Ы Ь Э Ю Я Э А В С D E F G H I J K L M N O P Q R S	
‘ ’ И Ь Э Ю Я Э А В С D E F G H I J K L M N O P Q R S	
T U V W X Y Z 0 1 2 3 4 5 6 7 8 9 - / < > space	
T U V W X Y Z 0 1 2 3 4 5 6 7 8 9 - / < >	

Thank you for purchasing a JVC product.

Please read all instructions carefully before operation, to ensure your complete understanding and to obtain the best possible performance from the unit.

Installation/connection are explained at the last section of this manual (reverse page, indicated with symbol).

MORE ABOUT THIS UNIT

Basic operations

- By pressing SRC on the unit, you can also turn on the power. If the source is ready, playback also starts.
- If you turn off the power while listening to a track, playback will start from where it had been stopped previously next time you turn on the power.

- The files on the CD-R/CD-RW are written using the "Packet Write" method.
- There are improper recording conditions (missing data, etc.) or media conditions (stained, scratched, warped, etc.).
- CD-RWs may require a longer readout time since the reflectance of CD-RWs is lower than that of regular CDs.

Tuner operations

- During SSM search...
 - All previously stored stations are erased and the stations are stored anew.
 - When SSM is over, the station stored in the lowest preset number will be automatically tuned in.
- Network-Tracking Reception requires two types of Radio Data System signals—PI (Programme Identification) and AF (Alternative Frequency) to work correctly.
- If a Traffic Announcement is received by TA Standby Reception, the volume level automatically changes to the preset level (TA VOL) if the current level is lower than the preset level.
- When Alternative Frequency Reception is activated (with AF selected), Network-Tracking Reception is also activated automatically. On the other hand, Network-Tracking Reception cannot be deactivated without deactivating Alternative Frequency Reception.

Playing an MP3/WMA disc

- This unit can play back MP3/WMA files with the extension code <.mp3> or <.wma> (regardless of the letter case—upper/lower).
- This unit can show the names of albums, artists (performer), and tag (Version 1.0, 1.1, 2.2, 2.3, or 2.4) for MP3 files and for WMA files
- This unit can play back MP3/WMA files meeting the conditions below:
 - Bit rate: 8 kbps — 320 kbps
 - Sampling frequency: 48 kHz, 44.1 kHz, 32 kHz (for MPEG-1) 24 kHz, 22.05 kHz, 16 kHz (for MPEG-2)
 - Disc format: ISO 9660 Level 1/ Level 2, Romeo, Joliet, Windows long file name
- The maximum number of characters for file/folder names vary depending on the disc format used (includes 4 extension characters—<.mp3> or <.wma>).
 - ISO 9660 Level 1: up to 12 characters; ISO 9660 Level 2: up to 31 characters; Romeo: up to 128 characters; Joliet: up to 64 characters; Windows long file name: up to 128 characters
- This unit can recognize a total of 512 files, 255 folders, and 8 hierarchical levels.
- This unit can play back files recorded in VBR (variable bit rate). Files recorded in VBR have a discrepancy in the elapsed time display, and do not show the actual elapsed time. In particular, this difference becomes noticeable after performing the search function.
- This unit cannot play back the following files:
 - MP3 files encoded in: MP3i and MP3 PRO format, in an inappropriate format, layer 1/2.
 - WMA files: encoded in lossless, professional, and voice format; not based upon Windows Media® Audio; copy-protected with DRM.
 - Files which have data such as AIFF, ATRAC3, etc.
- The search function works but search speed is not constant.

Disc operations

Caution for DualDisc playback

- The Non-DVD side of a "DualDisc" does not comply with the "Compact Disc Digital Audio" standard. Therefore, the use of Non-DVD side of a DualDisc on this product may not be recommended.

General

- This unit has been designed to reproduce CDs/CD Texts, and CD-Rs (Recordable)/CD-RWs (Rewritable) in audio CD (CD-DA) and MP3/WMA formats.

Playing a CD-R or CD-RW

- Use only "finalized" CD-Rs or CD-RWs.
- This unit can play back multi-session discs; however, unclosed sessions will be skipped while playing.
- Some CD-Rs or CD-RWs may not be played back on this unit:
 - Discs are dirty or scratched.
 - Moisture condensation has occurred on the lens inside the unit.
 - The pickup lens inside the unit is dirty.

MAINTENANCE

How to clean the connectors

Wipe the connectors with a cotton swab or cloth moistened with alcohol.

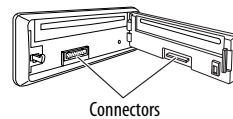

To keep discs clean

Wipe in a straight line from center of disc to edge. Do not use liquid cleaners, thinners, or benzene.



Moisture condensation

Moisture may condense on the lens inside the unit. Eject the disc and leave the unit turned on for a few hours until the moisture has evaporated.

To play new discs

Remove any rough areas from the inner and outer edges of the disc.



Do not use the following discs:

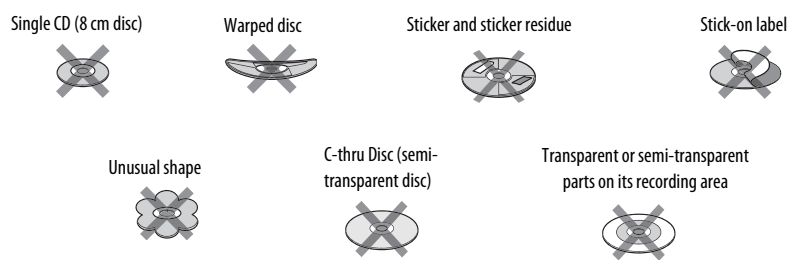

Basic operations

Control panel

- Turn on the power.
- Turn off the power [Hold].
- Attenuate the sound (if the power is on).

Check the current clock time/other information. See also "CLK DISP" of "General settings—PSM."

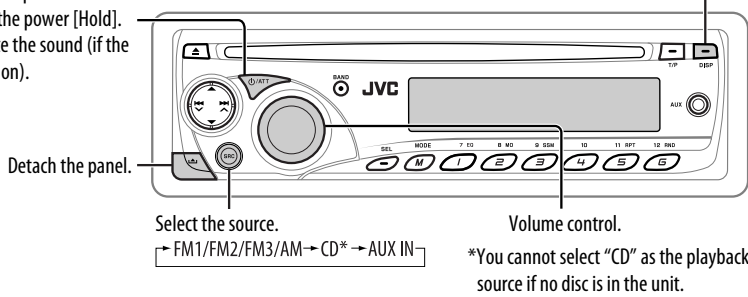

Display window

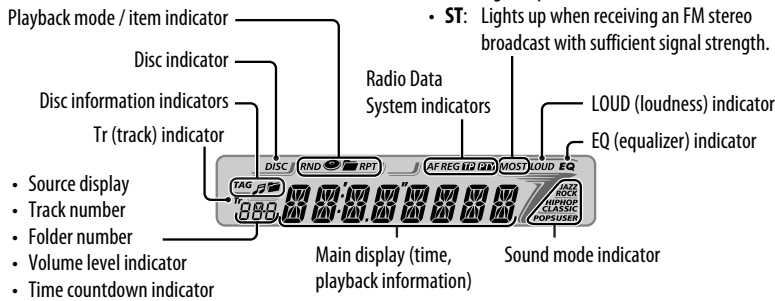

Disc operations

Eject disc.
• "NO DISC" appears. Press SRC to listen to another playback source.

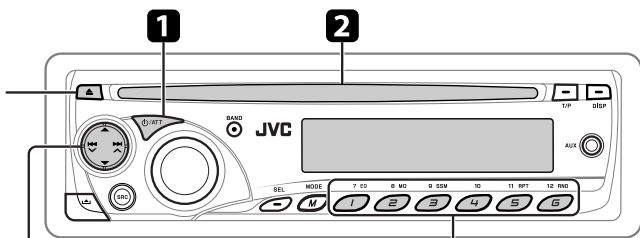

- [Left Arrow] / [Right Arrow] [Press] Go to the previous or next track.
 - [Left Arrow] / [Right Arrow] [Hold] Reverses or fast-forwards the track.
 - [Up Arrow] / [Down Arrow]: Go to the previous or next folder (for MP3/WMA discs).
- [Press] Select track (for CD) or folder* number (01 – 06).
- [Hold] Select track (for CD) or folder* number (07 – 12).
- * Folders are required to assigned with 2-digit numbers at the beginning.

- 1 Turn on the power.
- 2 Insert disc.
All tracks will be played repeatedly until you change the source or eject the disc.

Selecting the playback modes

After pressing M MODE, press the following buttons to...

11 RPT 5	TRK RPT : Plays the current track repeatedly.
	FLDR RPT* : Plays all tracks of the current folder repeatedly.
	RPT OFF : Cancels.
12 RND 6	FLDR RND* : Plays all tracks of the current folder, then the tracks of the next folder at random.
	ALL RND : Plays all tracks of the current disc at random.
	RND OFF : Cancels.

* Only while playing an MP3 or a WMA disc.

Skipping a track quickly during play

• For MP3/WMA disc, you can skip a track within the same folder.

Example: Select track 32

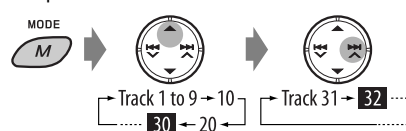

Changing the display information



While playing an audio CD or CD Text	While playing an MP3 or a WMA disc
(A) → (B) → Disc title/performer*1 → Track title*1 → (back to the beginning)	(A) → (B) → Album name/performer (folder name*2) → Track title (file name*2) → (back to the beginning)

- (A): The elapsed playing time with the current track number
- (B): Clock with the current track number

*1 If the current disc is an audio CD, "NO NAME" appears.
*2 If an MP3/WMA file does not have tags or "TAG DISP" is set to "TAG OFF," folder name and file name appear.

Prohibiting disc ejection

You can lock a disc in the loading slot.



To cancel the prohibition, repeat the same procedure.

External component operations

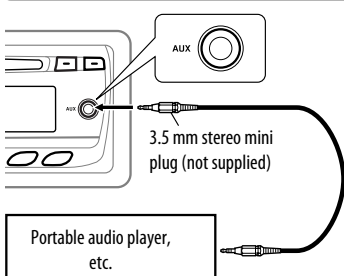

You can connect an external component to the AUX (auxiliary) input jack on the control panel.



Radio operations

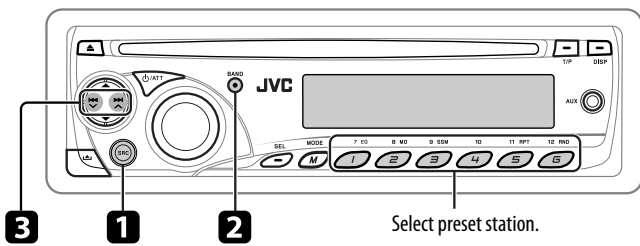

Note:
FM1 and FM2: 87.5 MHz – 108.0 MHz
FM3: 65.00 MHz – 74.00 MHz

- 1 Select "FM/AM."
- 2 Select the bands. → FM1 → FM2 → FM3 → AM
- 3 Search for a station—Auto Search.
Manual Search: Hold either one of the buttons until "M" flashes on the display, then press it repeatedly.

When an FM stereo broadcast is hard to receive

- 1 [MODE] M → [2] B MO
- Reception improves, but the stereo effect will be lost.
• MO indicator lights up.
To restore the stereo effect, repeat the same procedure.

FM station automatic presetting—SSM (Strong-station Sequential Memory)

You can preset 6 stations for each band.



Manual presetting (FM/AM)

Example: Storing the FM station of 92.5 MHz into preset number 4 of the FM1 band.

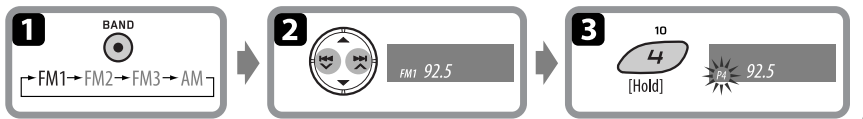

FM Radio Data System operations

Searching for your favourite FM Radio Data System programme

You can tune in to a station broadcasting your favourite programme by searching for a PTY code.

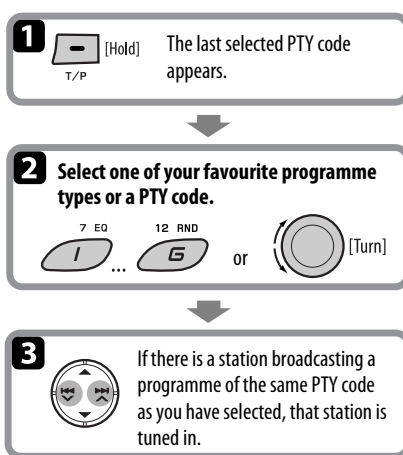

Storing your favourite programme type

You can store six favourite programme types.

Preset programme types in the number buttons (1 to 6):

1	2	3	4	5	6
POP M	ROCK M	EASY M	CLASSICS	AFFAIRS	VARIED

Example: Storing "ROCK M" into preset number 4.

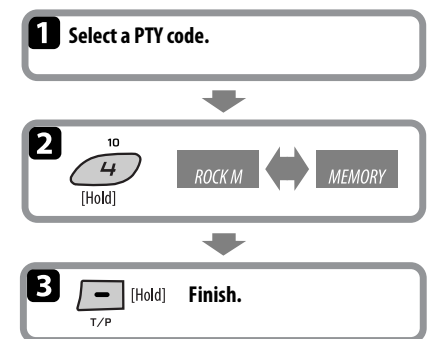

Standby receptions

TA Standby Reception

TA Standby Reception allows the unit to switch temporarily to Traffic Announcement (TA) from any source other than AM and FM3.

To activate/deactivate TA Standby Reception

- If the TP indicator flashes, TA Standby Reception is not yet activated.

To activate the reception, tune in to another station providing Radio Data System signals required for TA Standby Reception.

PTY Standby Reception

PTY Standby Reception allows the unit to switch temporarily to your favourite PTY programme from any source other than AM and FM3.

To activate and select your favourite PTY code for PTY Standby Reception, see "General settings—PSM: PTY-STBY."

- If the PTY indicator flashes, PTY Standby Reception is not yet activated.

To activate the reception, tune in to another station providing these signals.

PTY codes

NEWS, AFFAIRS, INFO, SPORT, EDUCATE, DRAMA, CULTURE, SCIENCE, VARIED, POP M (music), ROCK M (music), EASY M (music), LIGHT M (music), CLASSICS, OTHER M (music), WEATHER, FINANCE, CHILDREN, SOCIAL, RELIGION, PHONE IN, TRAVEL, LEISURE, JAZZ, COUNTRY, NATION M (music), OLDIES, FOLK M (music), DOCUMENT

Tracing the same programme — Network-Tracking Reception

When driving in an area where FM reception is not sufficient enough, this unit automatically tunes in to another FM Radio Data System station of the same network, possibly broadcasting the same programme with stronger signals.

To change the Network-Tracking Reception setting, see "General settings—PSM: AF-REG."

Programme A broadcasting on different frequency areas (01 – 05)

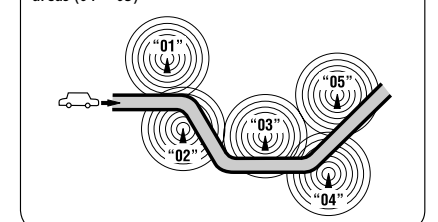

Automatic station selection — Programme Search

Usually when you press the number buttons, the preset station is tuned in. If the signals from the FM Radio Data System preset station are not sufficient for good reception, this unit, using the AF data, tunes in to another frequency broadcasting the same programme as the original preset station is broadcasting. See "General settings—PSM: P-SEARCH."

SETTINGS

Sound adjustments

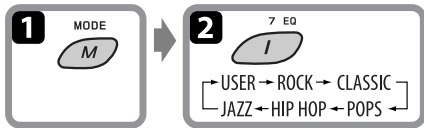

Indication (For)	BAS	TRE	LOUD
USER (Flat sound)	00	00	OFF
ROCK (Rock or disco music)	+03	+01	ON
CLASSIC (Classical music)	+01	-02	OFF
POPS (Light music)	+04	+01	OFF
HIP HOP (Funk or rap music)	+02	00	ON
JAZZ (Jazz music)	+02	+03	OFF

BAS: Bass; TRE: Treble; LOUD: (loudness)

Adjusting the sound



General settings—PSM

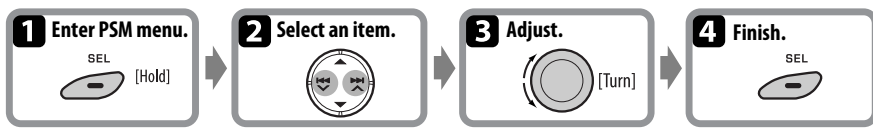

Indication	Item (___: Initial)	Setting
DEMO	• DEMO ON	: The display demonstration will be activated automatically if no operation is done for about 20 seconds.
	• DEMO OFF	: Cancels.
CLK DISP *1	• ON	: The clock time is shown on the display at all times when the power is turned off.
	• OFF	: Cancels; pressing DISP will show the clock time for about 5 seconds when the power is turned off.
CLOCK H (Hour)	0 – 23 (1 – 12)	: [Initial: 0 (0:00)]
CLOCK M (Minute)	00 – 59	: [Initial: 00 (0:00)]
24H/12H	• 24H • 12H	: See "Basic settings."
CLK ADJ *2	• AUTO	: The built-in clock is automatically adjusted using the CT (clock time) data in the Radio Data System signal.
	• OFF	: Cancels.
AF-REG *2	• AF	: When the currently received signals become weak, the unit switches to another station (the programme may differ from the one currently received). • The AF indicator lights up.
	• AF REG	: When the currently received signals become weak, the unit switches to another station broadcasting the same programme. • The AF and REG indicators light up.
	• OFF	: Cancels.
PTY-STBY *2	OFF , PTY codes	Activates PTY Standby Reception with one of the PTY codes.
TA VOL *2	VOL 00 – VOL 50 (or VOL 00 – VOL 30)*3	[Initial: VOL 15]
P-SEARCH *2	• ON	: Activates Programme Search.
	• OFF	: Cancels.
DIMMER	• ON	: Dims the display and button illumination.
	• OFF	: Cancels.
TEL	• MUTING 1/ MUTING 2	: Select either one which mutes the sounds while using a cellular phone.
	• OFF	: Cancels.
SCROLL *4	• ONCE	: Scrolls the displayed information once.
	• AUTO	: Repeats scrolling (at 5-second intervals).
	• OFF	: Cancels. • Pressing DISP for more than one second can scroll the display regardless of the setting.
AUX ADJ	A.ADJ 00 – A.ADJ 05	: Adjust the auxiliary input level to avoid the sudden increase of the output level when changing the source to external component connected to the AUX input jack on the control panel.
TAG DISP	• TAG ON	: Shows the tag while playing MP3/WMA tracks.
	• TAG OFF	: Cancels.
AMP GAIN	• LOW PWR	: VOL 00 – VOL 30 (Select if the maximum power of each speaker is less than 45 W to prevent the speaker from being damaged.)
	• HIGH PWR	: VOL 00 – VOL 50
IF BAND	• AUTO	: Increases the tuner selectivity to reduce interference noise between adjacent stations. (The stereo effect may be lost.)
	• WIDE	: Subject to the interference noise from adjacent stations, but the sound quality will not be degraded and the stereo effect will remain.

*1 If the power supply is not interrupted by turning off the ignition key of your car, it is recommended that you select "OFF" to save the car's battery.

*2 Only for FM Radio Data System stations.

*3 Depends on the amplifier gain control.

*4 Some characters or symbols will not be shown correctly (or will be blanked) on the display.

BAS *1 (bass) Adjust the bass.	-06 to +06
TRE *1 (treble) Adjust the treble.	-06 to +06
FAD *2 (fader) Adjust the front and rear speaker balance.	R06 to F06
BAL (balance) Adjust the left and right speaker balance.	L06 to R06
LOUD *1 (loudness) Boost low and high frequencies to produce a well-balanced sound at a low volume level.	LOUD ON or LOUD OFF
VOL (volume) Adjust the volume.	00 to 50 (or 00 to 30)*3

*1 When you adjust the bass, treble, or loudness, the adjustment you have made is stored for the currently selected sound mode including "USER."

*2 If you are using a two-speaker system, set the fader level to "00."

*3 Depending on the amplifier gain control setting—AMP GAIN.

TROUBLESHOOTING

Symptoms	Remedies/Causes	
General	• Sound cannot be heard from the speakers. • This unit does not work at all.	• Adjust the volume to the optimum level. • Check the cords and connections. Reset the unit.
	• SSM automatic presetting does not work. • Static noise while listening to the radio.	Store stations manually. Connect the aerial firmly.
FM/AM	• Disc cannot be played back. • CD-R/CD-RW cannot be played back. • Tracks on the CD-R/CD-RW cannot be skipped.	Insert the disc correctly. • Insert a finalized CD-R/CD-RW. • Finalize the CD-R/CD-RW with the component which you used for recording.
	• Disc can be neither played back nor ejected. • Disc sound is sometimes interrupted. • "NO DISC" appears on the display. • "PLEASE" and "EJECT" appear alternately on the display.	• Unlock the disc. • Eject the disc forcibly. • Stop playback while driving on rough roads. • Change the disc. • Check the cords and connections. Insert a playable disc into the loading slot. Press ▲, then insert a disc correctly.
Disc playback	• Disc cannot be played back. • Noise is generated. • A longer readout time is required ("READING" keeps flashing on the display). • Tracks are not played back in the order you have intended. • The elapsed playing time is not correct. • The correct characters are not displayed (e.g. album name).	• Use a disc with MP3/WMA tracks recorded in a format compliant with ISO 9660 Level 1, Level 2, Romeo, or Joliet. • Add the extension code <.mp3> or <.wma> to the file names. Skip to another track or change the disc. (Do not add the extension code <.mp3> or <.wma> to non-MP3 or WMA tracks.) Do not use too many hierarchical levels and folders. Playback order is determined when the files are recorded. This sometimes occurs during playback. This is caused by how the tracks are recorded on the disc. This unit can only display letters (upper case), numbers, and a limited number of symbols.
	• Microsoft and Windows Media are either registered trademarks or trademarks of Microsoft Corporation in the United States and/or other countries.	

SPECIFICATIONS

Audio amplifier section

Maximum Power Output:	Front/Rear: 45 W per channel
Continuous Power Output (RMS):	Front/Rear: 17 W per channel into 4 Ω , 40 Hz to 20 000 Hz at no more than 0.8% total harmonic distortion.
Load Impedance:	4 Ω (4 Ω to 8 Ω allowance)
Tone Control Range:	Bass: ± 12 dB at 100 Hz Treble: ± 12 dB at 10 kHz
Frequency Response:	40 Hz to 20 000 Hz
Signal-to-Noise Ratio:	70 dB
Other Terminal:	AUX (auxiliary) input jack

Tuner section

Frequency Range:	FM1/2: 87.5 MHz to 108.0 MHz FM3: 65.00 MHz to 74.00 MHz AM: MW: 522 kHz to 1 620 kHz LW: 144 kHz to 279 kHz
------------------	---

[FM Tuner]

Usable Sensitivity:	11.3 dBf (1.0 μ V/75 Ω)
50 dB Quietening Sensitivity:	16.3 dBf (1.8 μ V/75 Ω)
Alternate Channel Selectivity (400 kHz):	65 dB
Frequency Response:	40 Hz to 15 000 Hz
Stereo Separation:	30 dB

[MW Tuner]

Sensitivity/Selectivity:	20 μ V/35 dB
--------------------------	------------------

[LW Tuner]

Sensitivity:	50 μ V
--------------	------------

CD player section

Type:	Compact disc player
Signal Detection System:	Non-contact optical pickup (semiconductor laser)
Number of channels:	2 channels (stereo)
Frequency Response:	5 Hz to 20 000 Hz
Dynamic Range:	93 dB
Signal-to-Noise Ratio:	98 dB
Wow and Flutter:	Less than measurable limit
MP3 Decoding Format: (MPEG1/2 Audio Layer 3)	Max. Bit Rate: 320 kbps
WMA (Windows Media® Audio) Decoding Format:	Max. Bit Rate: 192 kbps

General

Power Requirement:	Operating Voltage: DC 14.4 V (11 V to 16 V allowance)
Grounding System:	Negative ground
Allowable Operating Temperature:	0°C to +40°C
Dimensions (W \times H \times D):	Installation Size (approx.): 182 mm \times 52 mm \times 160 mm Panel Size (approx.): 188 mm \times 58 mm \times 13 mm Mass (approx.): 1.3 kg (excluding accessories)

Design and specifications are subject to change without notice.

PREPARATION

This unit is designed to operate on **12 V DC, NEGATIVE ground electrical systems**. If your vehicle does not have this system, a voltage inverter is required, which can be purchased at JVC IN-CAR ENTERTAINMENT dealers.

WARNINGS

To prevent short circuits, we recommend that you disconnect the battery's negative terminal and make all electrical connections before installing the unit.

- **Be sure to ground this unit to the car's chassis again after installation.**

Notes:

- Replace the fuse with one of the specified rating. If the fuse blows frequently, consult your JVC IN-CAR ENTERTAINMENT dealer.
- It is recommended to connect to the speakers with maximum power of more than 45 W (both at the rear and at the front, with an impedance of **4 Ω to 8 Ω**). If the maximum power is less than 45 W, change "AMP GAIN" setting to prevent the speakers from being damaged (see "General settings—PSM").
- To prevent short-circuit, cover the terminals of the UNUSED leads with insulating tape.
- The heat sink becomes very hot after use. Be careful not to touch it when removing this unit.

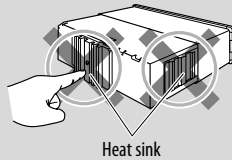

Parts list for installation and connection

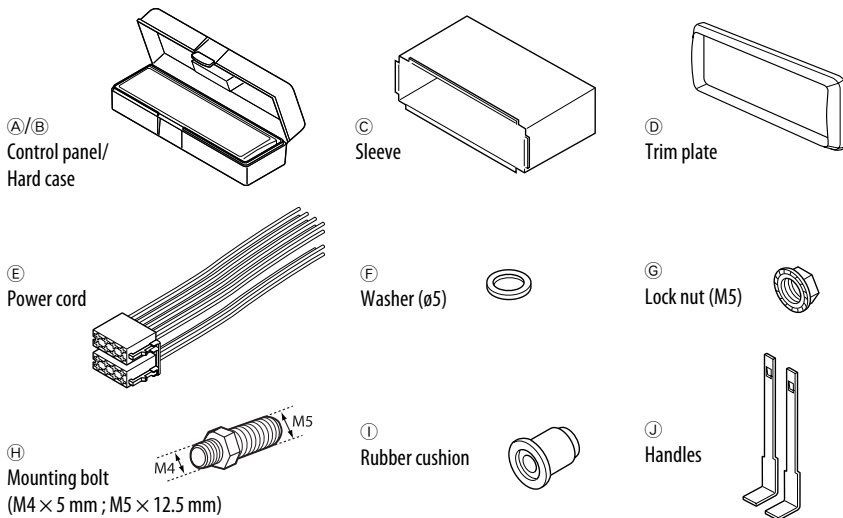

ELECTRICAL CONNECTIONS

Typical connections

Before connecting: Check the wiring in the vehicle carefully. Incorrect connection may cause serious damage to this unit. The leads of the power cord and those of the connector from the car body may be different in color.

- 1 Connect the colored leads of the power cord in the order specified in the illustration below.
- 2 Connect the aerial cord.
- 3 Finally connect the wiring harness to the unit.

Note: If your vehicle does not have any accessory terminal, move the fuse from the fuse position 1 (initial position) to fuse position 2, and connect the red lead (A7) to the positive (+) battery terminal.

- The yellow lead (A4) is not used in this case.

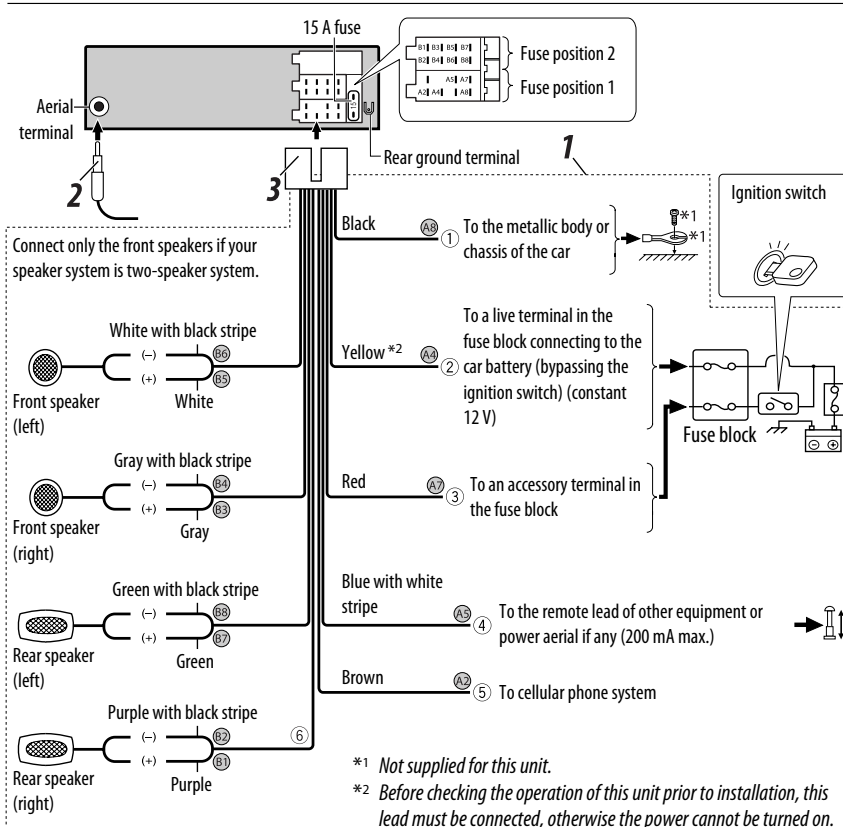

INSTALLATION

The following illustration shows a typical installation. If you have any questions or require information regarding installation kits, consult your JVC IN-CAR ENTERTAINMENT dealer or a company supplying kits.

- If you are not sure how to install this unit correctly, have it installed by a qualified technician.

In dash-mounting

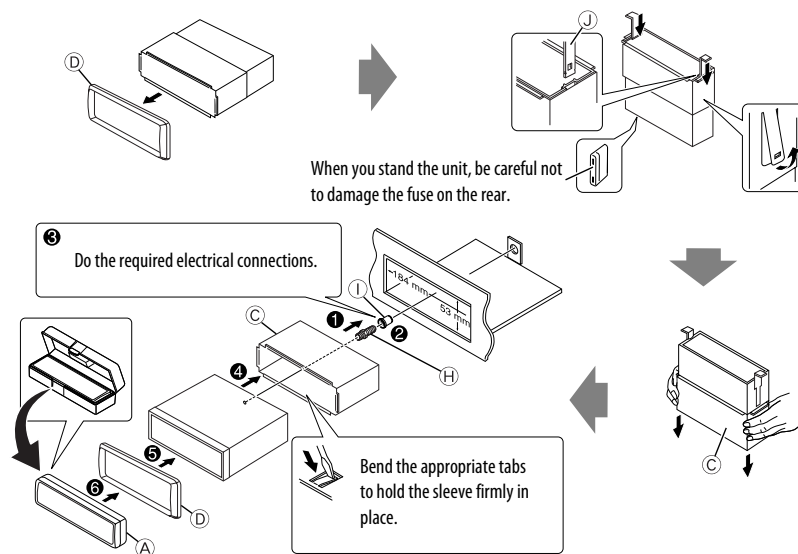

Removing the unit

Before removing the unit, release the rear section.

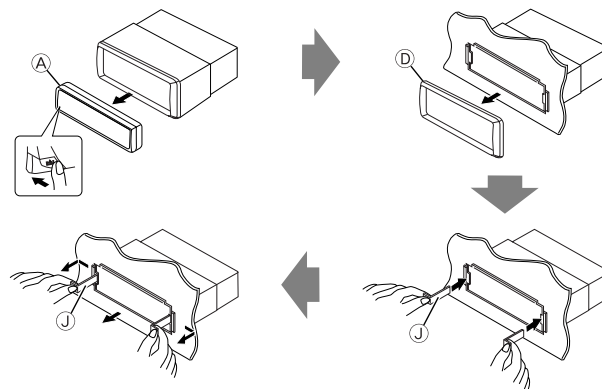

When using the optional stay

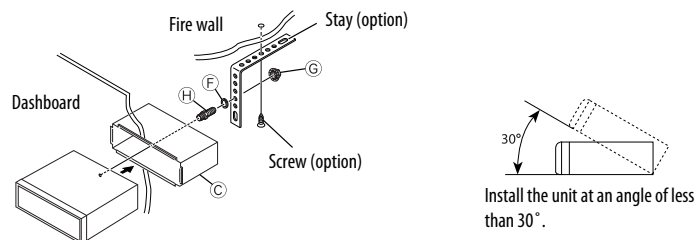

When installing the unit without using the sleeve

In a Toyota car for example, first remove the car radio and install the unit in its place.

Flat type screws (M5 × 8 mm)*

* Not supplied for this unit.

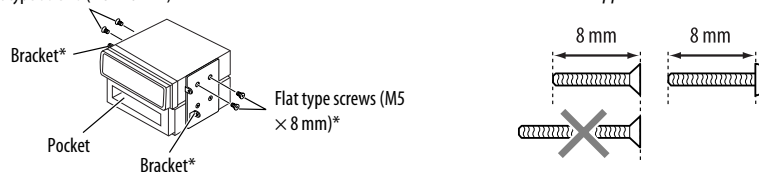

PRECAUTIONS on power supply and speaker connections

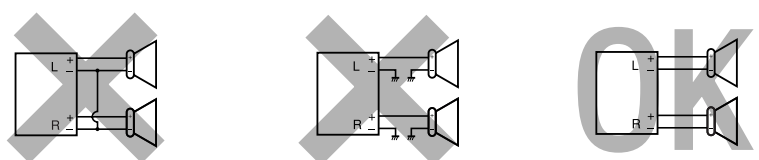

TROUBLESHOOTING

- **The fuse blows.**
 - * Are the red and black leads connected correctly?
- **Power cannot be turned on.**
 - * Is the yellow lead connected?
- **No sound from the speakers.**
 - * Is the speaker output lead short-circuited?
- **Sound is distorted.**
 - * Is the speaker output lead grounded?
 - * Are the "-" terminals of L and R speakers grounded in common?
- **Noise interfere with sounds.**
 - * Is the rear ground terminal connected to the car's chassis using shorter and thicker cords?
- **This unit becomes hot.**
 - * Is the speaker output lead grounded?
 - * Are the "-" terminals of L and R speakers grounded in common?
- **This unit does not work at all.**
 - * Have you reset your unit?

JVC KD-S16

CD RECEIVER: INSTRUCTIONS/INSTALLATION

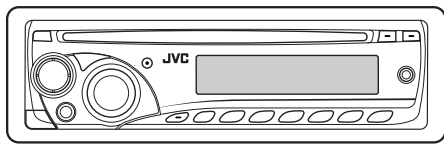

WMA MP3

GET0641-001A [J]

Thank you for purchasing a JVC product.

Please read all instructions carefully before operation, to ensure your complete understanding and to obtain the best possible performance from the unit.

Installation/connection are explained at the last section of this manual (reverse page, indicated with symbol).

For customer Use:

Enter below the Model No. and Serial No. which are located on the top or bottom of the cabinet. Retain this information for future reference.

Model No. _____

Serial No. _____

0709DTSMDTJEIN
EN

© 2009 Victor Company of Japan, Limited

ENGLISH

CANCELING THE DISPLAY DEMONSTRATIONS

1 Turn on the power.

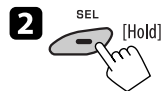

DEMO ON
(Initial setting)

3 Select "DEMO OFF."



DEMO OFF

4 Finish the procedure.



SETTING THE CLOCK

1 Turn on the power.

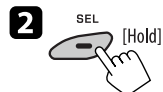

DEMO ON
(Initial setting)

3 Select "CLOCK H."



CLOCK H

4 Adjust the hour.



7:49

5 Select "CLOCK M."



CLOCK M

6 Adjust the minute.



7:49

7 Finish the procedure.

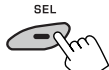

INFORMATION (For U.S.A.)

This equipment has been tested and found to comply with the limits for a Class B digital device, pursuant to Part 15 of the FCC Rules. These limits are designed to provide reasonable protection against harmful interference in a residential installation. This equipment generates, uses, and can radiate radio frequency energy and, if not installed and used in accordance with the instructions, may cause harmful interference to radio communications. However, there is no guarantee that interference will not occur in a particular installation. If this equipment does cause harmful interference to radio or television reception, which can be determined by turning the equipment off and on, the user is encouraged to try to correct the interference by one or more of the following measures:

- Reorient or relocate the receiving antenna.
- Increase the separation between the equipment and receiver.
- Connect the equipment into an outlet on a circuit different from that to which the receiver is connected.
- Consult the dealer or an experienced radio/TV technician for help.

Caution

Changes or modifications not approved by JVC could void the user's authority to operate the equipment.

PREPARATIONS

How to reset your unit

Reset the unit after installation is complete.

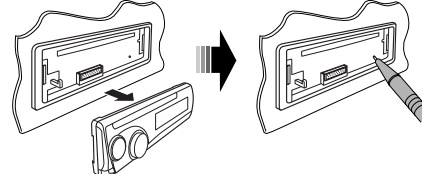

- Your preset adjustments will also be erased.

How to forcibly eject a disc



- Be careful not to drop the disc when it ejects.
- If this does not work, reset your unit.

Attaching the control panel

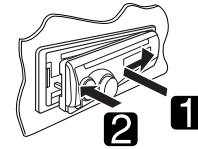

Detaching the control panel

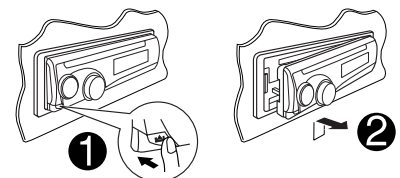

For safety...

- Do not raise the volume level too much, as this will block outside sounds, making driving dangerous.
- Stop the car before performing any complicated operations.

Temperature inside the car...

If you have parked the car for a long time in hot or cold weather, wait until the temperature in the car becomes normal before operating the unit.

Warning

If you need to operate the unit while driving, be sure to look around carefully or you may be involved in a traffic accident.

Caution on volume setting

Discs produce very little noise compared with other sources. Lower the volume before playing a disc to avoid damaging the speakers by the sudden increase of the output level.

IMPORTANT FOR LASER PRODUCTS

- CLASS 1 LASER PRODUCT
- CAUTION:** Do not open the top cover. There are no user serviceable parts inside the unit; leave all servicing to qualified service personnel.
- CAUTION:** (For U.S.A.) Visible and/or invisible class II laser radiation when open. Do not stare into beam.
(For Canada) Visible and/or invisible class 1M laser radiation when open. Do not view directly with optical instruments.
- REPRODUCTION OF LABEL: CAUTION LABEL, PLACED OUTSIDE THE UNIT.

CAUTION VISIBLE AND/OR INVISIBLE CLASS 1M LASER RADIATION WHEN OPEN. DO NOT VIEW DIRECTLY WITH OPTICAL INSTRUMENTS. IEC60825-1:2001 (ENG)	ATTENTION RAYONNEMENT LASER DE CLASSE 1M VISIBLE ET/OU INVISIBLE DE CLASSE 1M UNE FOIS OUVERT NE PAS REGARDER DIRECTEMENT AVEC DES INSTRUMENTS OPTIQUES. (FR)	AVISO RADIACION LASER DE CLASE 1M VISIBLE Y/O INVISIBLE CUANDO ESTA ABIERTO. NO MIRAR DIRECTAMENTE CON INSTRUMENTAL OPTICO. (ESP)	WARNING SYNLIK OCH/ELLER OYNLIK LASERSTRÅLNING, KLASS 1M, NÅR DENNA DEL ÄR ÖPPNAD. RESTRÄKT EJ STRÅLEN MED OPTISKA INSTRUMENT. (SWE)	注意 レーザー光線と目や 皮膚を直接見ると有害 のクラス1M レーザー放射が 発生する。 光学機器で直接 見ないでください。 (JPN)	CAUTION VISIBLE AND/OR INVISIBLE CLASS II LASER RADIATION WHEN OPEN. DO NOT STARE INTO BEAM. FDA 21 CFR (ENG)
--	---	--	---	---	--



[European Union only]

MORE ABOUT THIS UNIT

Basic operations

- By pressing SRC on the unit, you can also turn on the power. If the source is ready, playback also starts.
- If you turn off the power while listening to a disc, disc play will start from where it had been stopped previously next time you turn on the power.
- When no disc is loaded in the unit, you cannot select "CD" as the playback source.

Tuner operations

- During SSM search...
 - All previously stored stations are erased and the stations are stored anew.
 - Received stations are preset in No. 1 (lowest frequency) to No. 6 (highest frequency).
 - When SSM is over, the station stored in No. 1 will be automatically tuned in.

Disc operations

Caution for DualDisc playback

- The Non-DVD side of a "DualDisc" does not comply with the "Compact Disc Digital Audio" standard. Therefore, the use of Non-DVD side of a DualDisc on this product may not be recommended.

General

- This unit has been designed to reproduce CDs/CD Texts, and CD-Rs (Recordable)/CD-RWs (Rewritable) in audio CD (CD-DA) and MP3/WMA formats.
- After ejecting a disc, "NO DISC" appears and you cannot operate some of the buttons. Insert another disc or press SRC to select another playback source.

Playing a CD-R or CD-RW

- Use only "finalized" CD-Rs or CD-RWs.
- This unit can play back multi-session discs; however, unclosed sessions will be skipped while playing.
- Some CD-Rs or CD-RWs may not be played back on this unit:
 - Discs are dirty or scratched.
 - Moisture condensation has occurred on the lens inside the unit.
 - The pickup lens inside the unit is dirty.

- The files on the CD-R/CD-RW are written using the "Packet Write" method.
- There are improper recording conditions (missing data, etc.) or media conditions (stained, scratched, warped, etc.).
- CD-RWs may require a longer readout time since the reflectance of CD-RWs is lower than that of regular CDs.

Playing an MP3/WMA disc

- This unit can play back MP3/WMA files with the extension code <.mp3> or <.wma> (regardless of the letter case—upper/lower).
- This unit can show the names of albums, artists (performer), and tag (Version 1.0, 1.1, 2.2, 2.3, or 2.4) for MP3 files and for WMA files.
- This unit can display only one-byte characters. No other characters can be correctly displayed.
- This unit can play back MP3/WMA files meeting the conditions below:
 - Bit rate: 8 kbps — 320 kbps
 - Sampling frequency:
 - 48 kHz, 44.1 kHz, 32 kHz (for MPEG-1)
 - 24 kHz, 22.05 kHz, 16 kHz (for MPEG-2)
 - Disc format: ISO 9660 Level 1/Level 2, Romeo, Joliet, Windows long file name

- The maximum number of characters for file/folder names vary depending on the disc format used (includes 4 extension characters—<.mp3> or <.wma>).
 - ISO 9660 Level 1: up to 12 characters; ISO 9660 Level 2: up to 31 characters; Romeo: up to 64 characters; Joliet: up to 32 characters; Windows long file name: up to 126 characters
- This unit can recognize a total of 512 files, 255 folders, and 8 hierarchical levels.
- This unit can play back files recorded in VBR (variable bit rate).
 - Files recorded in VBR have a discrepancy in the elapsed time display, and do not show the actual elapsed time. In particular, this difference becomes noticeable after performing the search function.
- This unit cannot play back the following files:
 - MP3 files encoded in: MP3i and MP3 PRO format, in an inappropriate format, layer 1/2.
 - WMA files: encoded in lossless, professional, and voice format; not based upon Windows Media® Audio; copy-protected with DRM.
 - Files which have data such as WAVE, AT3C3, etc.
- The search function works but search speed is not constant.

Basic operations

Control panel

- Turn on the power.
- Turn off the power [Hold].
- Attenuate the sound (if the power is on).

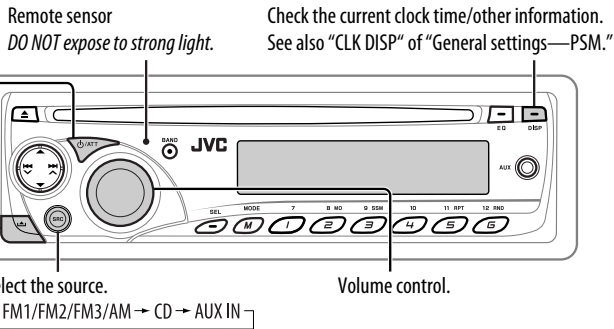

Display window

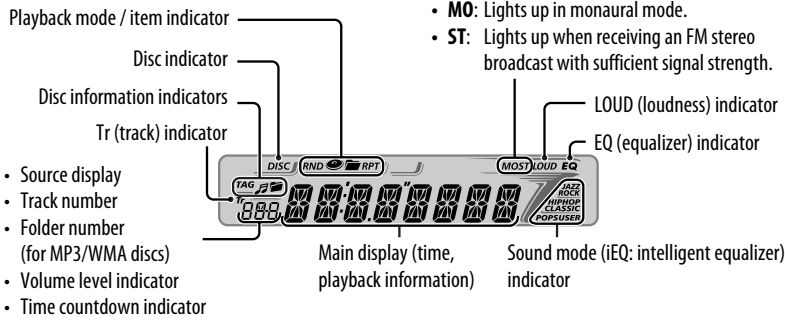

Remote controller—RM-RK50

■ Installing battery

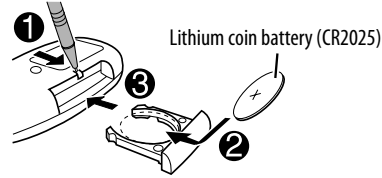

Warning: To prevent accidents and damage

- Do not install any battery other than CR2025 or its equivalent.
- Store out of reach of children.
- Do not recharge, short, or dismantle.
- Do not dispose of in fire.
- Do not carry around with other metallic materials.

For USA-California Only: This product contains a CR Coin Cell Lithium Battery which contains Perchlorate Material—special handling may apply. See www.dtsc.ca.gov/hazardouswaste/perchlorate

■ Features

- Turns the power on if pressed briefly or attenuates the sound when power is on.
- Turns the power off if pressed and held.
- Changes the FM/AM bands with ▲ U.
- Changes the preset stations with D ▼.
- Changes the folders of MP3/WMA discs.
- Adjusts the volume level.
- Selects the sound mode (iEQ: intelligent equalizer).
- Selects the source.
- Searches for stations if pressed briefly.
- Fast-forwards or reverses the track if pressed and held.
- Changes the track of the disc if pressed briefly.

Radio operations

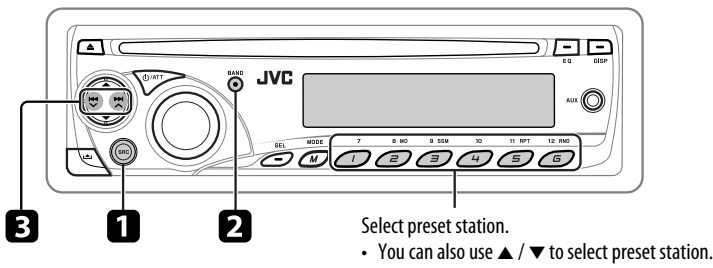

- 1 Select "FM/AM."
- 2 Select the bands. (FM1 → FM2 → FM3 → AM)
- 3 Search for a station—Auto Search.
Manual Search: Hold either one of the buttons until "M" flashes on the display, then press it repeatedly.

When an FM stereo broadcast is hard to receive

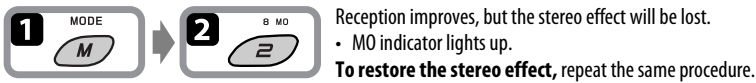

FM station automatic presetting—SSM (Strong-station Sequential Memory)

You can preset six stations for each band.



Manual presetting

Example: Storing the FM station of 92.5 MHz into preset number 4 of the FM1 band.

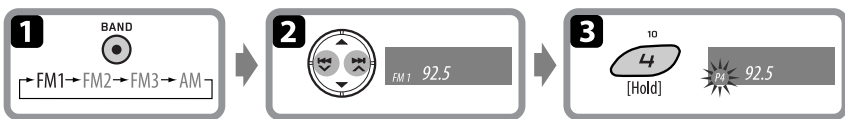

External component operations

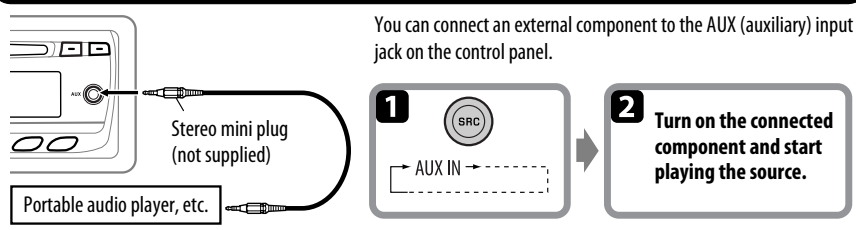

Disc operations

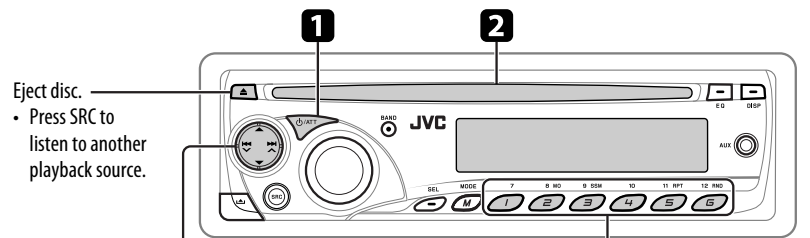

- Press SRC to listen to another playback source.
- ◀◀◀ / ▶▶▶: [Press] Go to the next or previous track. [Hold] Fast-forwards or reverses the track.
- ▲ / ▼: Go to the next or previous folder (for MP3/WMA discs).
- [Press] Select track (for CD) or folder* (for MP3/WMA) number (01 – 06).
- [Hold] Select track (for CD) or folder* (for MP3/WMA) number (07 – 12).

* Folders are required to assigned with 2-digit numbers at the beginning.

- 1 Turn on the power.
- 2 Insert disc.
All tracks will be played repeatedly until you change the source or eject the disc.

Selecting the playback modes

After pressing M MODE, press the following buttons to...

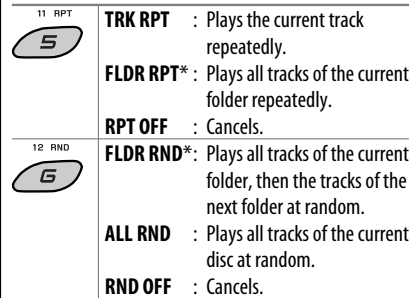

* Only for MP3/WMA.

Changing the display information

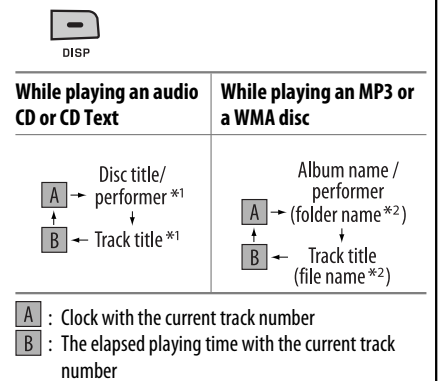

*1 If the current disc is an audio CD, "NO NAME" appears.
*2 If an MP3/WMA file does not have tags or "TAG DISP" is set to "TAG OFF," folder name and file name appear.

Skipping a track quickly during play

- For MP3/WMA disc, you can skip a track within the same folder.
Example: Select track 32

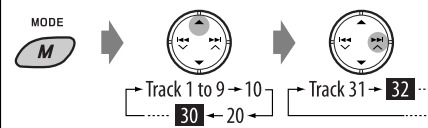

Prohibiting disc ejection

You can lock a disc in the loading slot.



To cancel the prohibition, repeat the same procedure.

SETTINGS

■ Sound adjustments



Preset values	BAS (bass)	MID (mid-range)	TRE (treble)	LOUD (loudness)
USER (Flat sound)	00	00	00	OFF
ROCK (Rock or disco music)	+03	00	+02	OFF
CLASSIC (Classical music)	+01	00	+03	OFF
POPS (Light music)	+02	+01	+02	OFF
HIP HOP (Funk or rap music)	+04	-02	+01	OFF
JAZZ (Jazz music)	+03	00	+03	OFF

■ Adjusting the sound

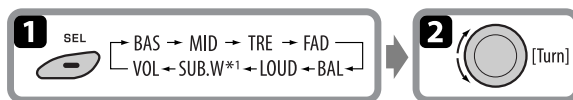

- BAS***2 (bass) : Adjust the bass. -06 to +06
- MID***2 (mid-range) : Adjust the middle frequencies sound level. -06 to +06
- TRE***2 (treble) : Adjust the treble. -06 to +06
- FAD***3 (fader) : Adjust the front and rear speaker balance. R06 to F06
- BAL** (balance) : Adjust the left and right speaker balance. L06 to R06

LOUD *4 (loudness) : Boost low and high frequencies to produce a well-balanced sound at a low volume level.	LOUD ON or LOUD OFF
SUB.W (subwoofer) : Adjust the subwoofer output level.	00 to 08
VOL (volume) : Adjust the volume.	00 to 50 (or 00 to 30)*5

*1 Displayed only when "L/O MODE" is set to "WOOFER."
*2 When you adjust the bass, mid-range, or treble, the adjustment you have made is stored for the currently selected sound mode (iEQ) including "USER."
*3 If you are using a two-speaker system, set the fader level to "00."
*4 The adjustment made (LOUD ON/LOUD OFF) will be applied to all sound modes (iEQ).
*5 Depending on the amplifier gain control setting. See reverse page →

General settings—PSM

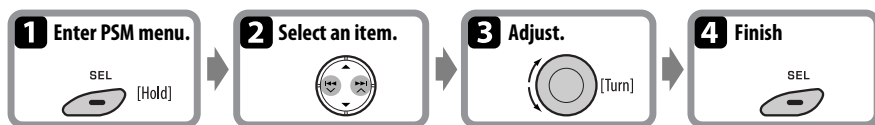

Indication	Item (___: Initial)	Setting
DEMO	• DEMO ON • DEMO OFF	: Display demonstration will be activated automatically if no operation is done for about 20 seconds. : Cancels.
CLK DISP *1	• ON • OFF	: Clock time is shown on the display at all times when the power is turned off. : Cancels; pressing DISP will show the clock time for about 5 seconds when the power is turned off.
CLOCK H (Hour)	1 – 12	: [Initial: 1 (1:00)]
CLOCK M (Minute)	00 – 59	: [Initial: 00 (1:00)]
DIMMER	• ON • OFF	: Dims the display and button illumination. : Cancels.
SCROLL *2	• ONCE • AUTO • OFF	: Scrolls the displayed information once. : Repeats scrolling (at 5-second intervals). : Cancels. • Pressing DISP for more than one second can scroll the display regardless of the setting.
L/O MODE	• REAR • WOOFER	: Select if the REAR LINE OUT terminals are used for connecting the speakers (through an external amplifier). : Select if the REAR LINE OUT terminals are used for connecting a subwoofer.
WOOFER *3	• LOW • MID • HIGH	: Frequencies lower than 90 Hz are sent to the subwoofer. : Frequencies lower than 135 Hz are sent to the subwoofer. : Frequencies lower than 180 Hz are sent to the subwoofer.
AUX ADJ	A.ADJ 00 – A.ADJ 05	: Adjust the auxiliary input level to avoid the sudden increase of the output level when changing the source from external component connected to the AUX input jack on the control panel.
TAG DISP	• TAG ON • TAG OFF	: Shows the Tag while playing MP3/WMA tracks. : Cancels.
AMP GAIN *4	• LOW PWR • HIGH PWR	: VOL 00 – VOL 30 (Select if the maximum power of each speaker is less than 50 W to prevent damaging the speaker.) : VOL 00 – VOL 50
AREA	• AREA US • AREA EU • AREA SA	: When using in North/Central/South America. AM/FM intervals are set to 10 kHz/200 kHz. : When using in any other areas. AM/FM intervals are set to 9 kHz/50 kHz (100 kHz during auto search). : When using in South American countries where FM interval is 100 kHz. AM interval is set to 10 kHz.

*1 If the power supply is not interrupted by turning off the ignition key of your car, it is recommended that you select "OFF" to save the car's battery.

*2 Some characters or symbols will not be shown correctly (or will be blanked) on the display.

*3 Displayed only when "L/O MODE" is set to "WOOFER."

*4 The volume level automatically changes to "VOL 30" if you change to "LOW PWR" while the volume level is set higher than "VOL 30."

TROUBLESHOOTING

	Symptoms	Remedies/Causes
General	• Sound cannot be heard from the speakers.	• Adjust the volume to the optimum level. • Check the cords and connections.
	• The buttons on the unit do not work as you intended.	If you press M MODE, some buttons work differently from its original function. Wait for 5 seconds or press M MODE again.
	• This unit does not work at all.	Reset the unit.
FM/AM	• SSM automatic presetting does not work.	Store stations manually.
	• Static noise while listening to the radio.	Connect the antenna firmly.
Disc playback	• Disc ejects.	Insert the disc correctly.
	• CD-R/CD-RW cannot be played back. • Tracks on the CD-R/CD-RW cannot be skipped.	• Insert a finalized CD-R/CD-RW. • Finalize the CD-R/CD-RW with the component which you used for recording.
	• Disc can be neither played back nor ejected.	• Unlock the disc. • Eject the disc forcibly.
	• Disc sound is sometimes interrupted.	• Stop playback while driving on rough roads. • Change the disc. • Check the cords and connections.
MP3/WMA playback	• "NO DISC" appears on the display. • "PLEASE" and "EJECT" appear alternately on the display.	Insert a playable disc into the loading slot.
	• Disc cannot be played back.	• Use a disc with MP3/WMA tracks recorded in a format compliant with ISO 9660 Level 1, Level 2, Romeo, or Joliet. • Add the extension code <.mp3> or <.wma> to the file names.
	• Noise is generated.	Skip to another track or change the disc. (Do not add the extension code <.mp3> or <.wma> to non-MP3 or WMA tracks.)
	• A longer readout time is required ("READING" keeps flashing on the display).	Do not use too many hierarchical levels and folders.
	• Tracks are not played back in the order you have intended.	Playback order is determined when the files are recorded.
	• The elapsed playing time is not correct.	This sometimes occurs during playback. This is caused by how the tracks are recorded on the disc.
• The correct characters are not displayed (e.g. album name).	This unit can only display alphabets (upper case), numbers, and a limited number of symbols.	

• Microsoft and Windows Media are either registered trademarks or trademarks of Microsoft Corporation in the United States and/or other countries.

MAINTENANCE

How to clean the connectors

Wipe the connectors with a cotton swab or cloth moistened with alcohol.

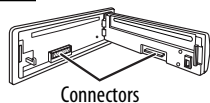

Connectors

To keep discs clean

Wipe in a straight line from center of disc to edge. Do not use liquid cleaners, thinners, or benzene.



To play new discs

Remove any rough areas from the inner and outer edges of the disc.



Do not use the following discs:

Single CD—8 cm (3-3/16") disc



Unusual shape



Warped disc



C-thru Disc (semi-transparent disc)

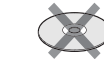

Sticker and sticker residue



Transparent or semi-transparent parts on its recording area



Stick-on label



SPECIFICATIONS

Audio amplifier section

Power Output:
20 W RMS × 4 Channels at 4 Ω and
≤ 1% THD+N
Signal-to-Noise Ratio:
80 dBA (reference: 1 W into 4 Ω)



Load Impedance: 4 Ω (4 Ω to 8 Ω allowance)
Tone Control Range: Bass: ±12 dB at 60 Hz
Mid-range: ±12 dB at 1 kHz
Treble: ±12 dB at 7.5 kHz
Frequency Response: 40 Hz to 20 000 Hz
Line-Out Level/Impedance: 2.5 V/20 kΩ load (full scale)
Output Impedance: 1 kΩ
Subwoofer-Out Level/Impedance: 2.5 V/20 kΩ load (full scale)

If a kit is necessary for your car, consult your telephone directory for the nearest car audio speciality shop.

Tuner section

Frequency Range:
FM: 87.5 MHz to 107.9 MHz
(with channel interval set to 100 kHz or 200 kHz)
87.5 MHz to 108.0 MHz
(with channel interval set to 50 kHz)
AM: 530 kHz to 1 710 kHz
(with channel interval set to 10 kHz)
531 kHz to 1 602 kHz
(with channel interval set to 9 kHz)

[FM Tuner]

Usable Sensitivity: 11.3 dBf (1.0 μV/75 Ω)
50 dB Quieting Sensitivity: 16.3 dBf (1.8 μV/75 Ω)
Alternate Channel Selectivity (400 kHz): 65 dB
Frequency Response: 40 Hz to 15 000 Hz
Stereo Separation: 35 dB

[AM Tuner]

Sensitivity/Selectivity: 20 μV/35 dB

CD player section

Type: Compact disc player
Signal Detection System: Non-contact optical pickup (semiconductor laser)
Number of channels: 2 channels (stereo)
Frequency Response: 5 Hz to 20 000 Hz
Dynamic Range: 93 dB
Signal-to-Noise Ratio: 98 dB
Wow and Flutter: Less than measurable limit
MP3 Decoding Format: MPEG1/2 Audio Layer 3
Max. Bit Rate: 320 kbps
WMA (Windows Media® Audio) Decoding Format :
Max. Bit Rate: 192 kbps

General

Power Requirement: Operating Voltage: DC 14.4 V
(11 V to 16 V allowance)
Grounding System: Negative ground
Allowable Operating Temperature:
0°C to +40°C (32°F to 104°F)
Dimensions (W × H × D):
Installation Size (approx.):
182 mm × 52 mm × 160 mm
(7-3/16" × 2-1/16" × 6-5/16")
Panel Size (approx.):
188 mm × 58 mm × 5 mm
(7-7/16" × 2-5/16" × 1/4")
Mass (approx.):
1.3 kg (2.9 lbs) (excluding accessories)

Design and specifications are subject to change without notice.

Having TROUBLE with operation?
Please reset your unit
Still having trouble??
Call 1-800-252-5722 (USA ONLY)
<http://www.jvc.com>

PREPARATION

You need the installation kits which corresponds to your car.

- Mark all the check boxes (☑) to make sure you have follow the instructions and the listed parts.

Check the battery system in your car

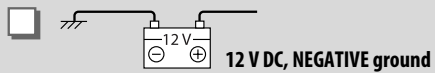

Prepare this before installation

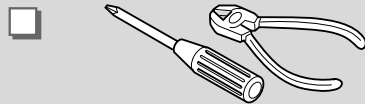

TROUBLESHOOTING



- **The fuse blows.** ⇒ Are the red and black leads connected correctly?
- **Power cannot be turned on.** ⇒ Is the yellow lead connected?
- **No sound from the speakers.** ⇒ Is the speaker output lead short-circuited?
- **Sound is distorted.** ⇒ Is the speaker output lead grounded? ; Are the “-” terminals of L and R speakers grounded in common?
- **Noise interfere with sounds.** ⇒ Is the rear ground terminal connected to the car’s chassis using shorter and thicker cords?
- **This unit becomes hot.** ⇒ Is the speaker output lead grounded? ; Are the “-” terminals of L and R speakers grounded in common?
- **This unit does not work at all.** ⇒ Have you reset your unit?

Parts list for installation and connection

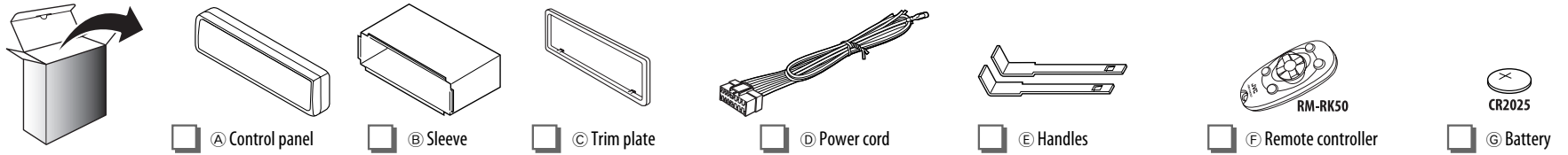

INSTALLATION

The following illustration shows a typical installation. If you are not sure how to install this unit correctly, contact your JVC car audio dealer or a company supplying kits.

In-dash mounting

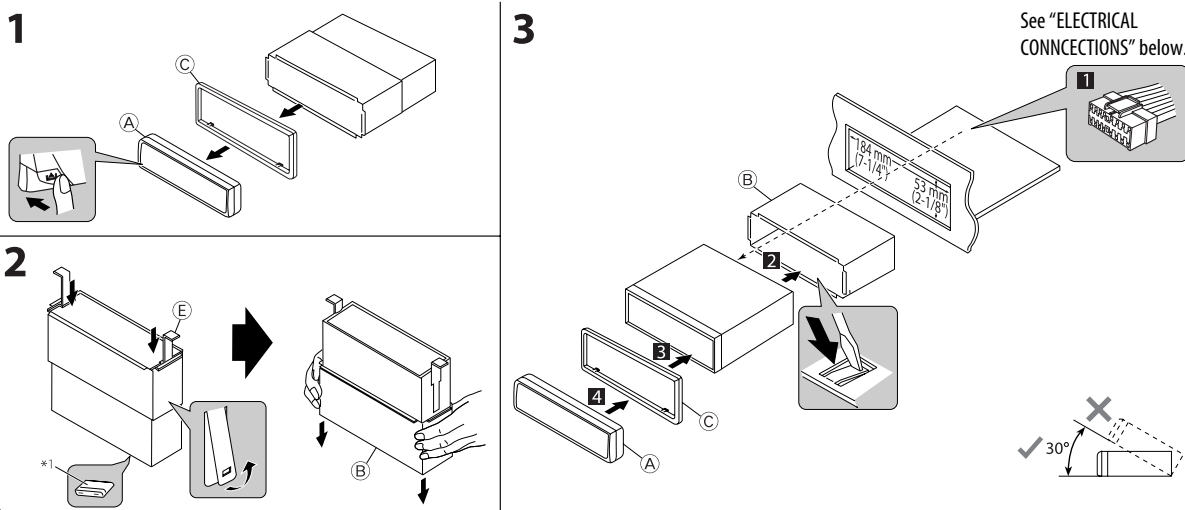

When installing the unit without using the sleeve

In a Toyota car for example, first remove the car radio and install the unit in its place.

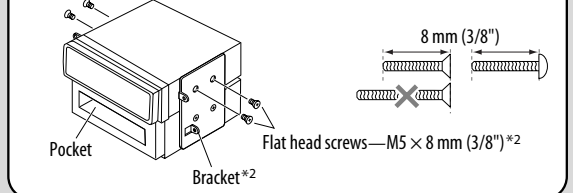

Removing the unit

Release the rear section first...

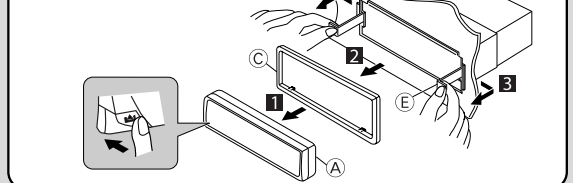

ELECTRICAL CONNECTIONS

Make sure to disconnect the battery's negative terminal.

- Be sure to ground this unit to the car's chassis again after installation.

Note:

It is recommended to connect to the speakers with maximum power of more than 50 W (both at the rear and at the front, with an impedance of 4 Ω to 8 Ω). If the maximum power is less than 50 W, change “AMP GAIN” setting to prevent the speakers from being damaged (see “General settings—PSM”).

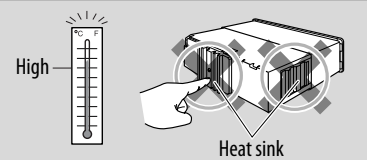

Typical connections

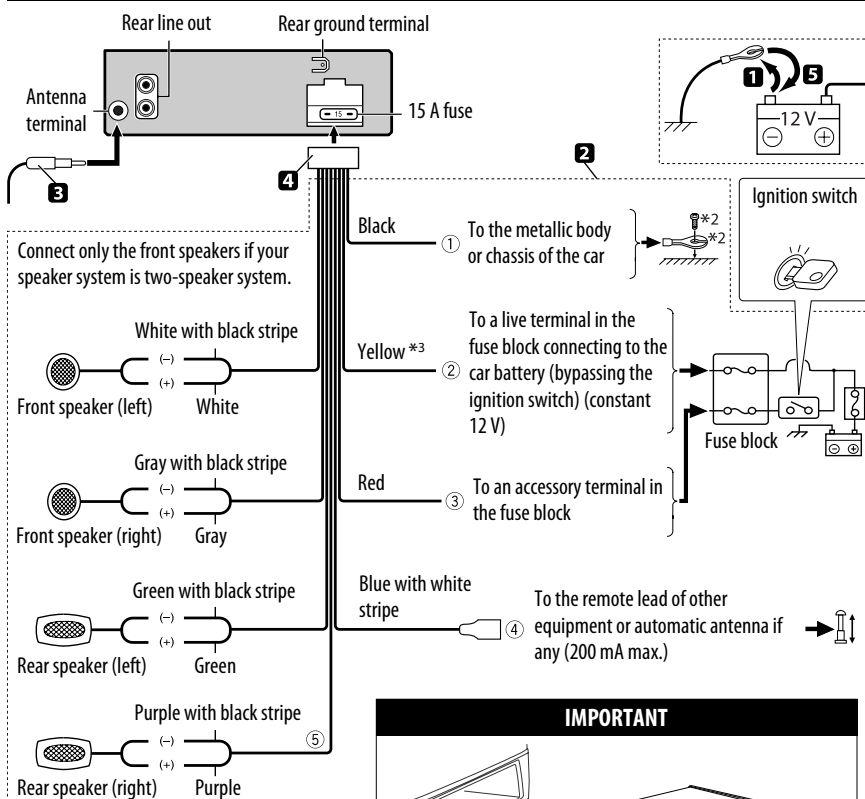

IMPORTANT

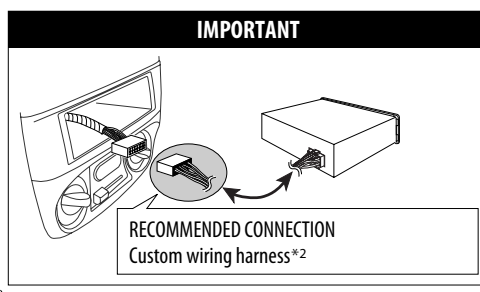

Connecting the external amplifier or subwoofer

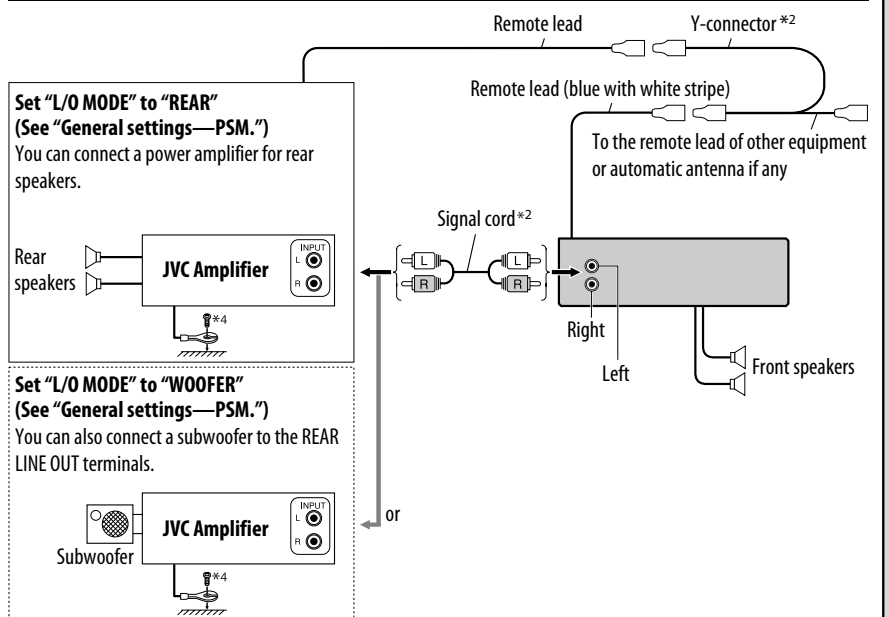

PRECAUTIONS on power supply and speaker connections

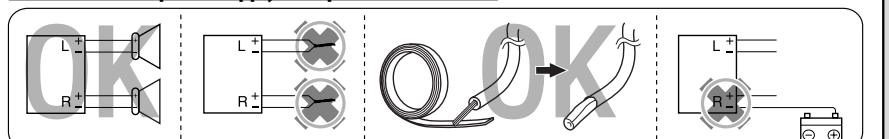

- *1 When you stand the unit, be careful not to damage the fuse on the rear.
- *2 Not supplied for this unit.
- *3 Before checking the operation of this unit prior to installation, this lead must be connected, otherwise the power cannot be turned on.
- *4 Firmly attach the ground wire to the metallic body or to the chassis of the car—to the place uncoated with paint (if coated with paint, remove the paint before attaching the wire). Failure to do so may cause damage to the unit.